



Refrigeration and Air conditioning Engineering.

3rd year – refrigeration and Air conditioning

Course

WATER PIPING SYSTEMS DESIGN

Part2

Lecture -11-

WATER PIPING FOR CLOSED RE-CIRCULATION SYSTEM

Select the proper water piping for a closed re-circulation system, the following information must be available:

1. Total volume flow rate of water to be circulated as well as volume flow rate to be circulated in each branch run.
2. Pressure drop across condensers and heat exchanger (this varies widely and must be obtained from equipment manufacturer).
3. Type of pipe to be used.

Example 2

1. **3.78 lit/s** total water to be circulated.
2. Length of runs with units, valves and fitting as shown in Fig. 2.
3. **Pressure Drop 3.5 m** of water in each unit **condenser at 0.63 lit/s** flow rate.
4. **4.5 m water** for plate **type heat exchanger at 3.78 lit/s** flow rate.
5. Schedule 40 pipe (assume to have "fairly rough" interior surface).
6. Solution: (Refer to Fig. 2)

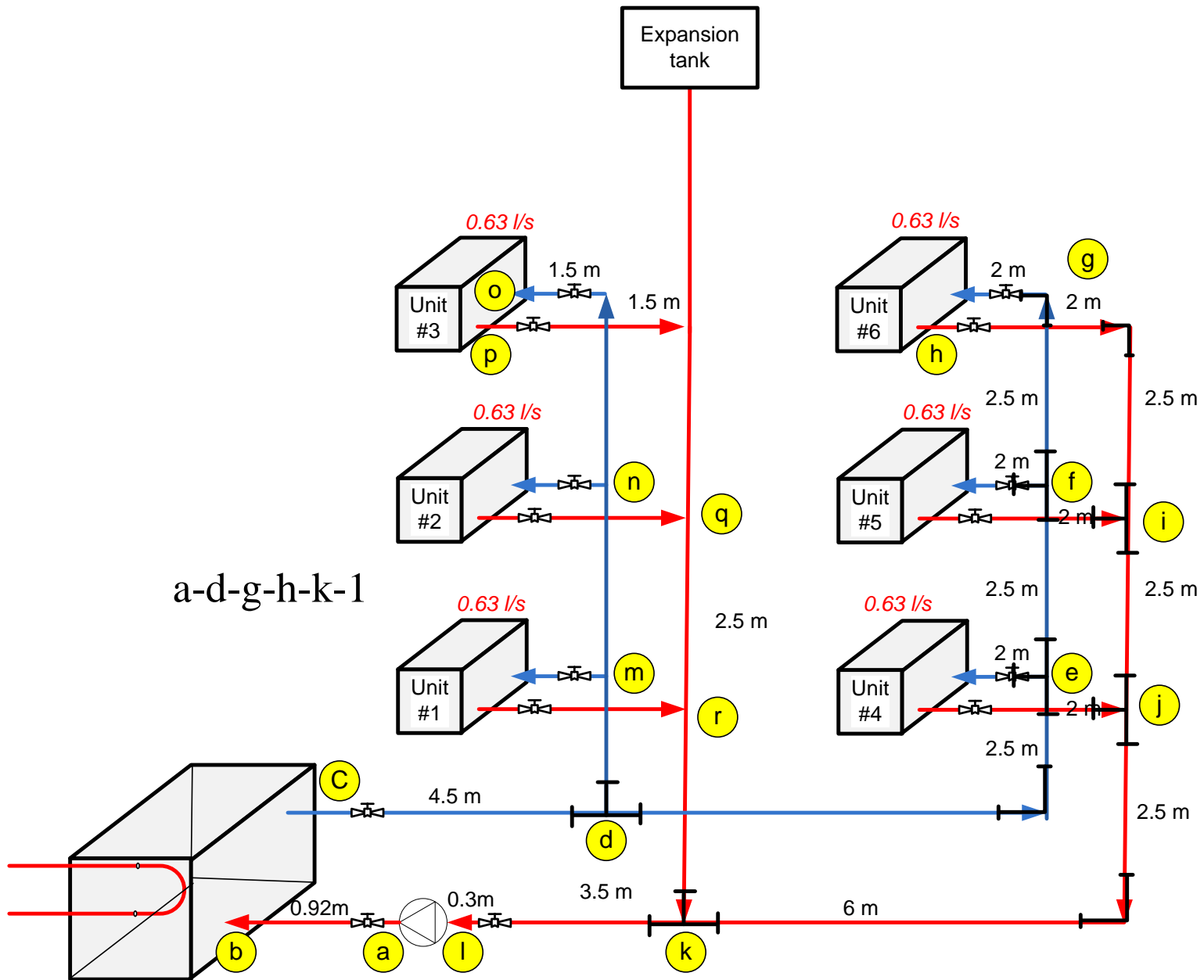

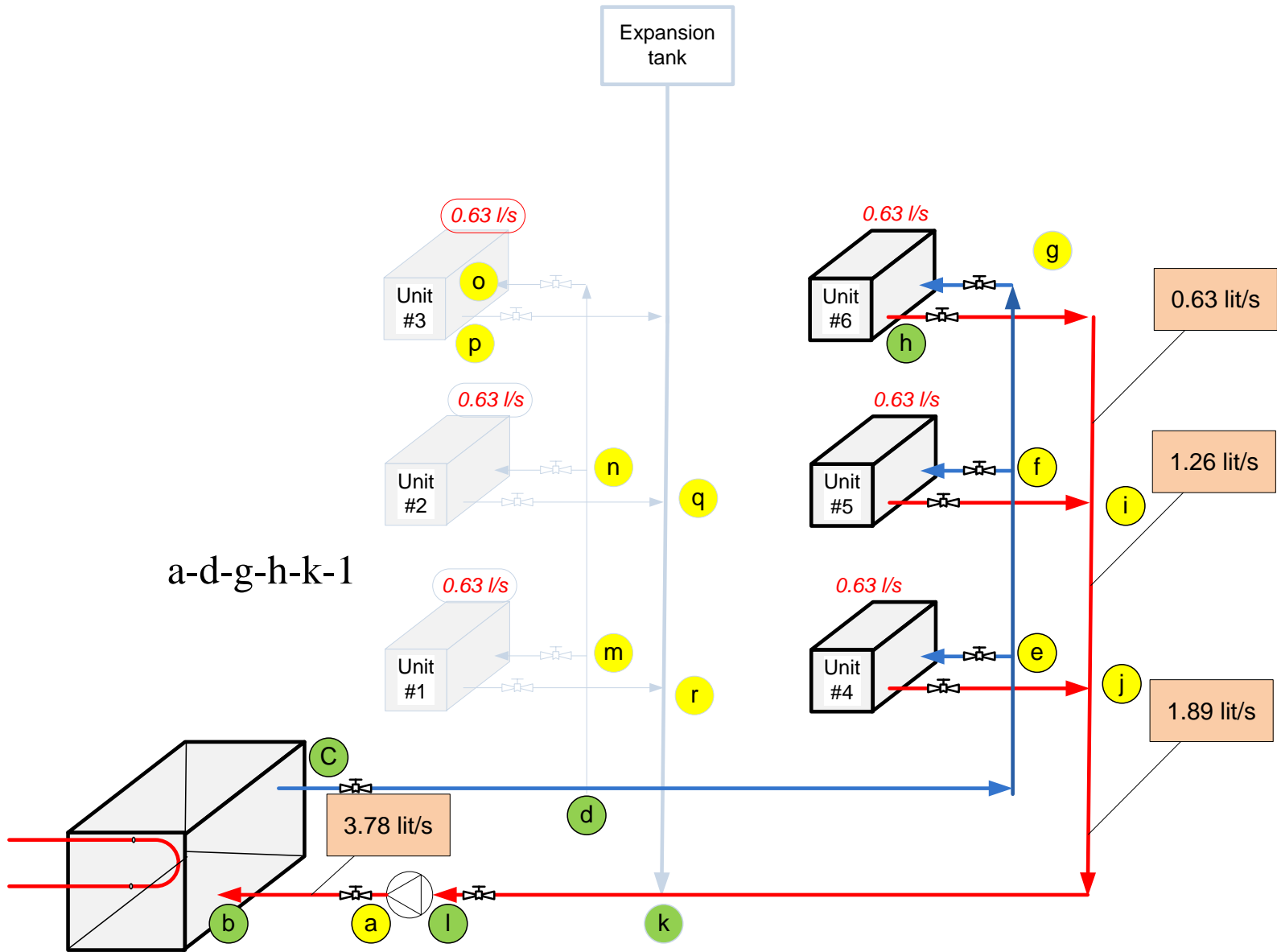

a-d-g-h-k-l

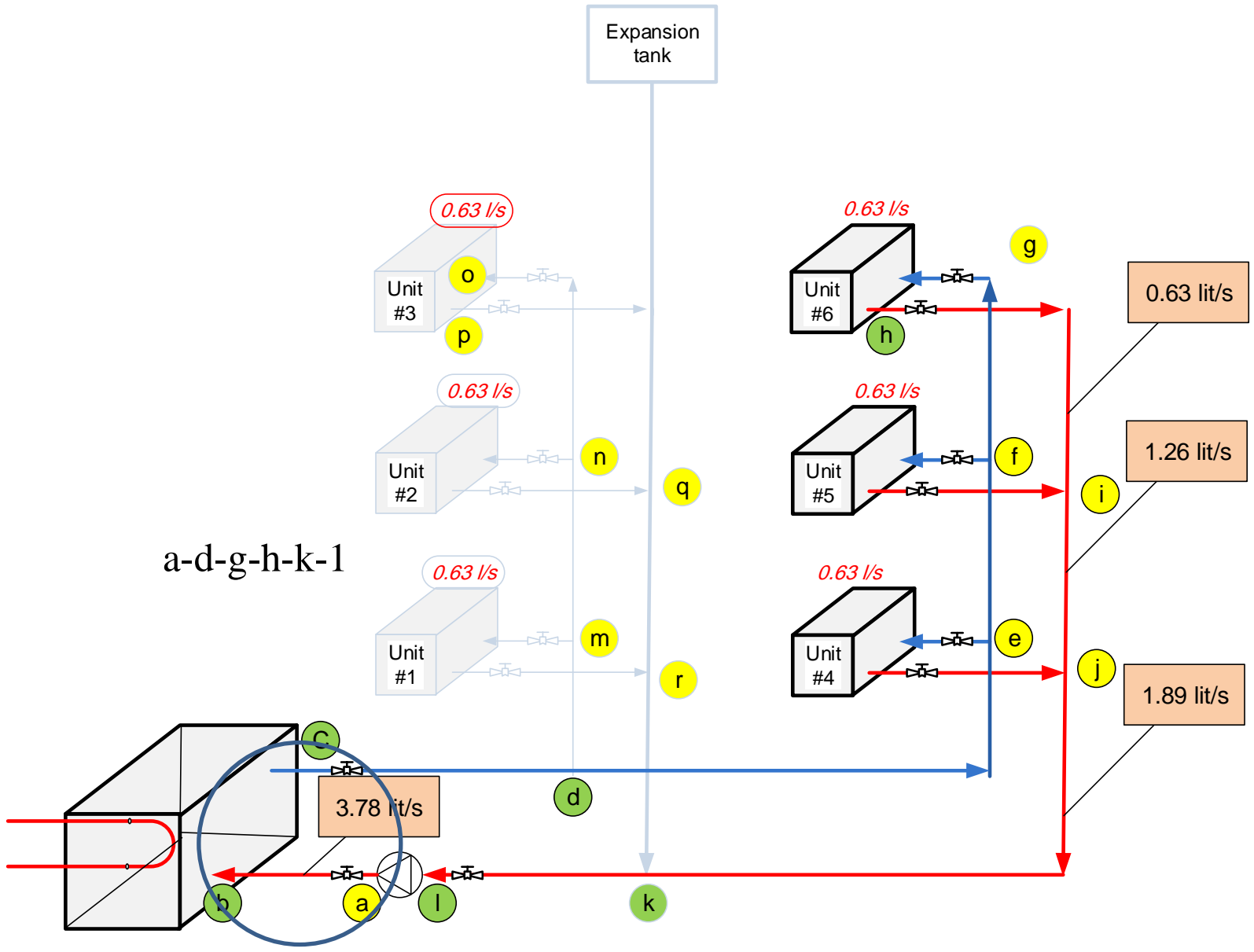

a-d-g-h-k-l

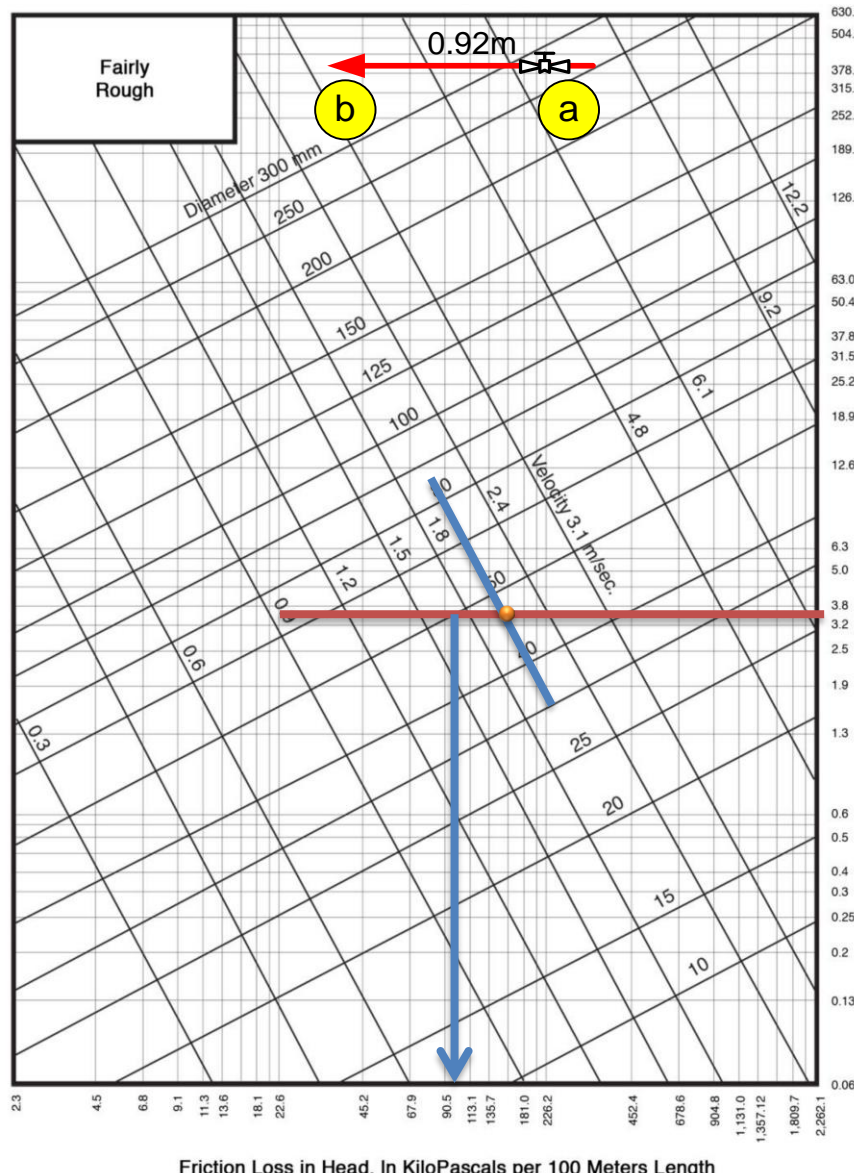

pipe diameter is 50 mm, pressure drop is 101 kPa/100m

Pipe length = 0.92
 Equiv. length due to gate valve (table 3) is 0.702 m

Pressure drop = $(0.92 + 0.702) * (101 / 100) = 1.7$ kPa.

Table (3) Valve loss in equivalent (mm) length

Nominal diameter mm								
	Globe	Angle		Angle	Gate	Swing Check	Y type strainer	
		60° Y	45° Y				Flanged	Screwed end
10	5185	2440	1830	1830	183	1525	-----	-----
15	5490	2745	2135	2135	2135	1830	-----	915
20	6710	3355	2745	2745	275	2440	-----	1220
25	8845	4575	3660	3660	305	3050	-----	1525
32	11590	6100	4575	4575	458	4270	-----	2745
40	13115	7320	5490	5490	549	4880	-----	3050
50	16775	9150	7320	7320	702	6100	8235	4270
65	21045	10675	8845	8845	854	7625	8540	6100
80	30500	15250	12505	12505	1220	10675	14640	-----
100	36600	17690	14335	14335	1373	12200	18300	-----
125	42700	21655	17690	17690	1830	15250	24400	-----
150	51850	26840	21350	21350	2135	18300	33550	-----

Run (a-b) 3.78 lit/s, velocity 2 m/s

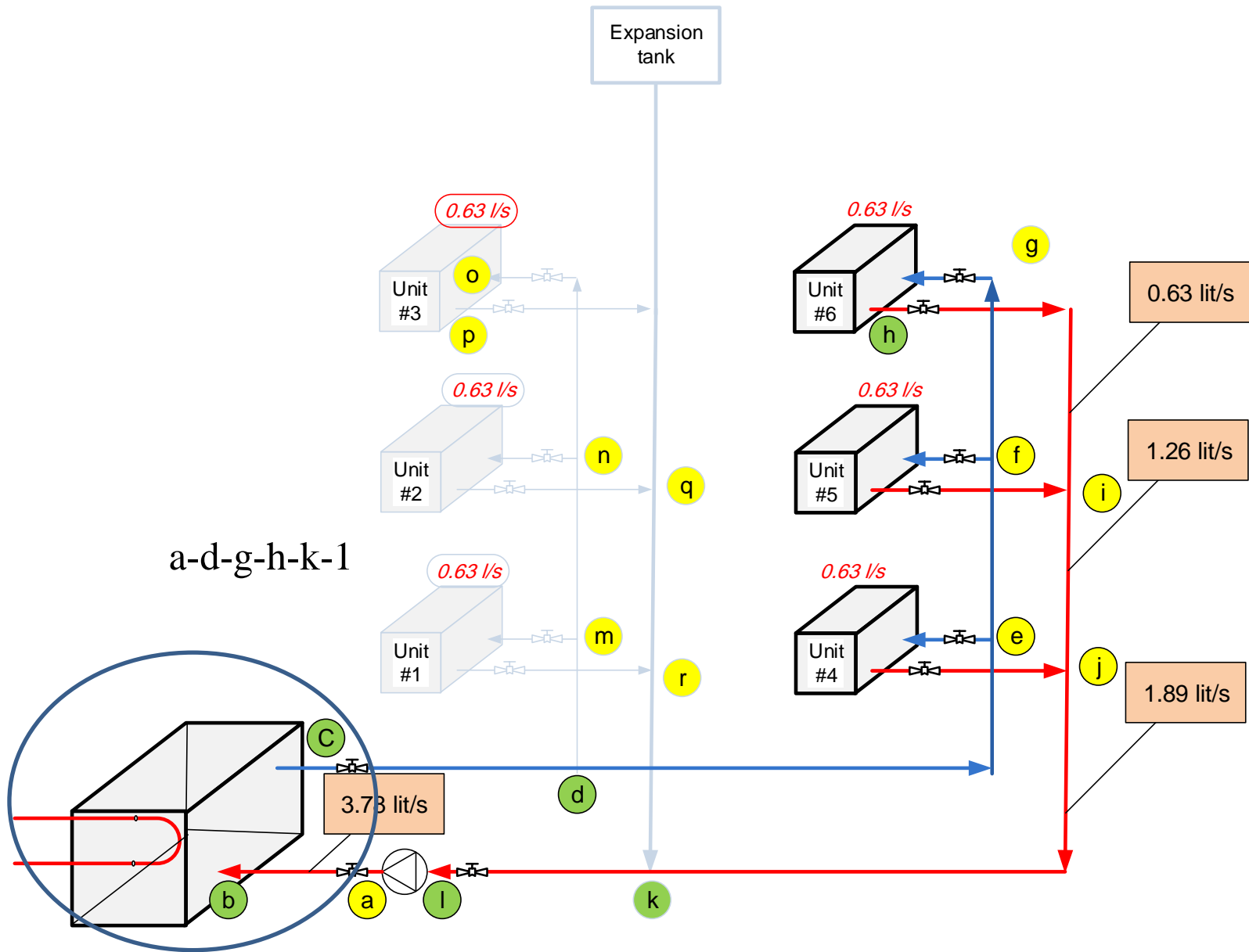

a-d-g-h-k-l

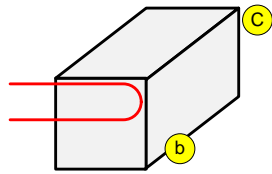

Run (b-c) 3.78 lit/s, velocity 2 m/s

Run b-c: 4.5 m water for plate type heat exchanger at 3.78 lit/s flow rate.

Pressure drop= $4.5 * 1.01 = 4.6$ kPa.

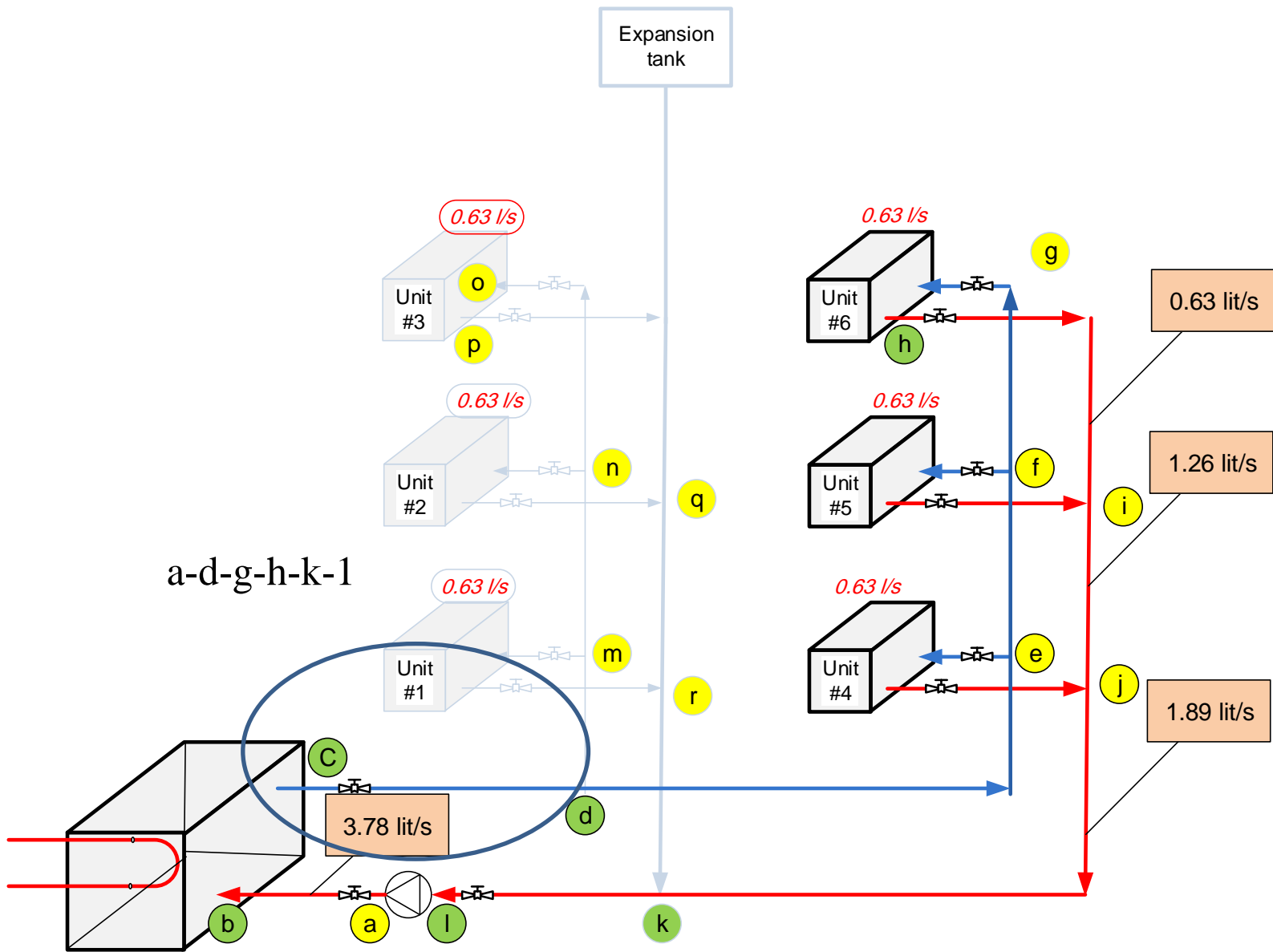

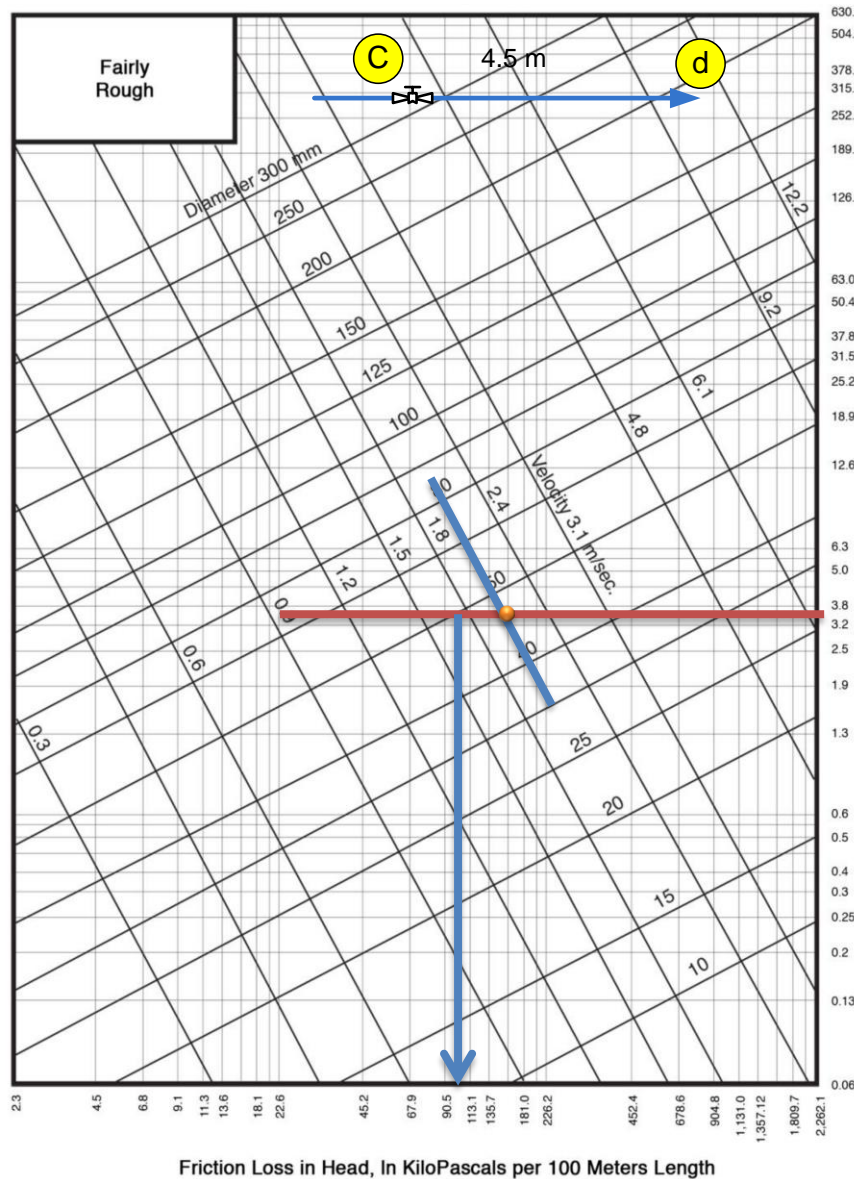

Fairly Rough

4.5 m

C

d

Diameter 300 mm

Velocity 3.1 m/sec.

Friction Loss in Head, In KiloPascals per 100 Meters Length

Run c-d:) 3.78 lit/s, velocity 2 m/s
pipe diameter is 50 mm, pressure drop is 101 kPa/100m

Pipe length =4.5

Equiv. length due to gate valve (table 3) is 0.702 m

Pressure drop = (4.5+0.702)*(101/100)=5.3 kPa.

Table (3) Valve loss in equivalent (mm) length

Nominal diameter mm	Globe		Angle		Gate	Swing Check	Y type strainer	
	Globe	Angle		Flanged			Screwed end	
		60° Y	45° Y		Angle			
10	5185	2440	1830	1830	183	1525	-----	-----
15	5490	2745	2135	2135	2135	1830	-----	915
20	6710	3355	2745	2745	275	2440	-----	1220
25	8845	4575	3660	3660	305	3050	-----	1525
32	11590	6100	4575	4575	458	4270	-----	2745
40	13115	7320	5490	5490	549	4880	-----	3050
50	16775	9150	7320	7320	702	6100	8235	4270
65	21045	10675	8845	8845	854	7625	8540	6100
80	30500	15250	12505	12505	1220	10675	14640	-----
100	36600	17690	14335	14335	1373	12200	18300	-----
125	42700	21655	17690	17690	1830	15250	24400	-----
150	51850	26840	21350	21350	2135	18300	33550	-----

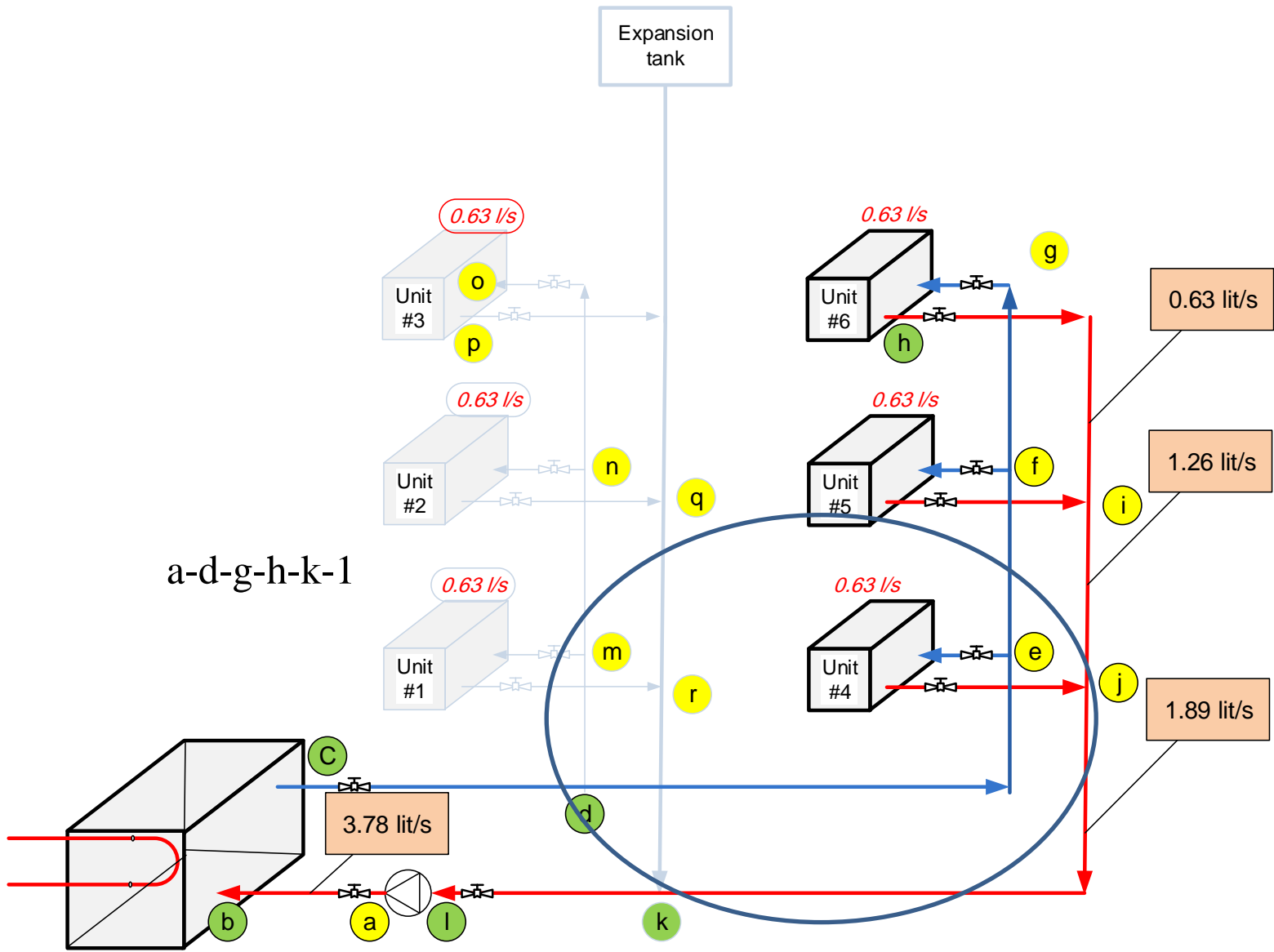

Run d-e; 1.89 lit/s, velocity 2 m/s

pipe diameter is 40 mm, pressure drop is 113kPa/100m

Pipe length = 6+2.5=8.5 m

Equiv. length due to 90° std. elbow (table 4) is 1.22 m

Equiv. length due to side Tee through (table 4) is 0.793 m

Pressure drop = (8.5+1.22+0.793)*(113/100)=11.88 kPa.

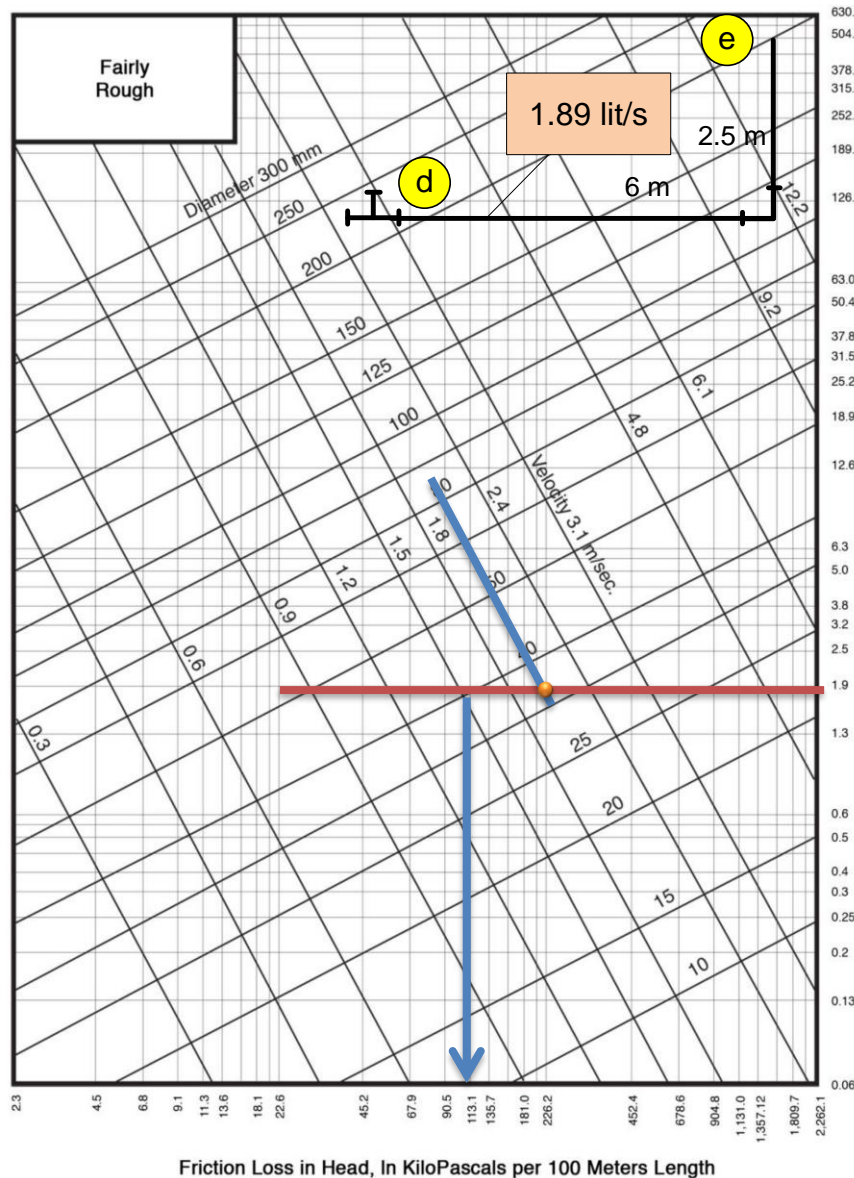

Flow in Liters per Second

Friction Loss in Head, In KiloPascals per 100 Meters Length

Table (4) Fitting loss in equivalent (mm)

Nominal diameter Mm	Smooth bend elbows						Smooth bend Tee			
	90° Std	90° Long rad.	90° Street	45° Std	45° Street	180° Std.	Flow through branch	No reduction	Reduce d ¼	Reduce d ½
10	427	275	702	214	336	702	824	275	366	427
15	488	305	763	244	397	763	915	305	427	488
20	610	427	976	275	488	976	1220	427	580	610
25	793	519	1251	397	641	1251	1525	519	702	793
32	1007	702	1708	519	915	1708	2135	702	946	1007
40	1220	793	1922	641	1037	1922	2440	793	1129	1220
50	1525	1007	2501	793	1373	2501	3050	1007	1434	1525
65	1830	1220	3050	976	1586	3050	3660	1251	1708	1830
90	2745	1830	4575	1434	2227	4575	4575	1800	2440	2745
100	3050	2135	5185	1586	2593	5185	6405	2044	2745	3050
125	3965	2440	6405	1983	3355	6405	7625	2501	3660	3965
150	4880	3050	7625	2410	3965	7625	9150	3050	4270	4880

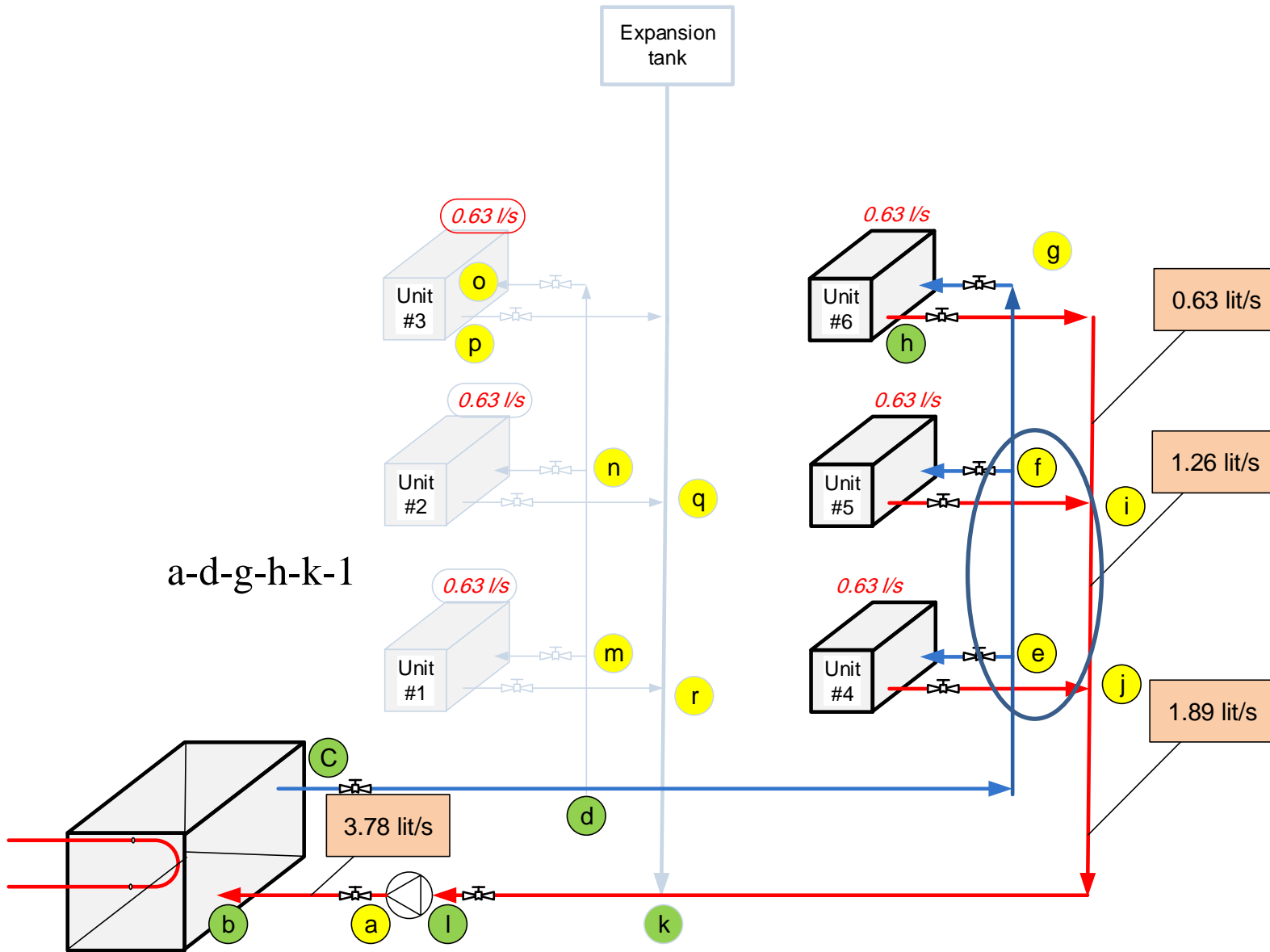

a-d-g-h-k-l

Run e-f: 1.26 lit/s, velocity 2 m/s

diameter is 32mm, pressure drop is 124.4 kPa/100m

. Pipe length = 2.5

Equiv. length due to side Tee through (table 4) is 0.702 m

Pressure drop=

$(2.5+0.702) * (124.4/100) = 3.98 \text{ kPa}$

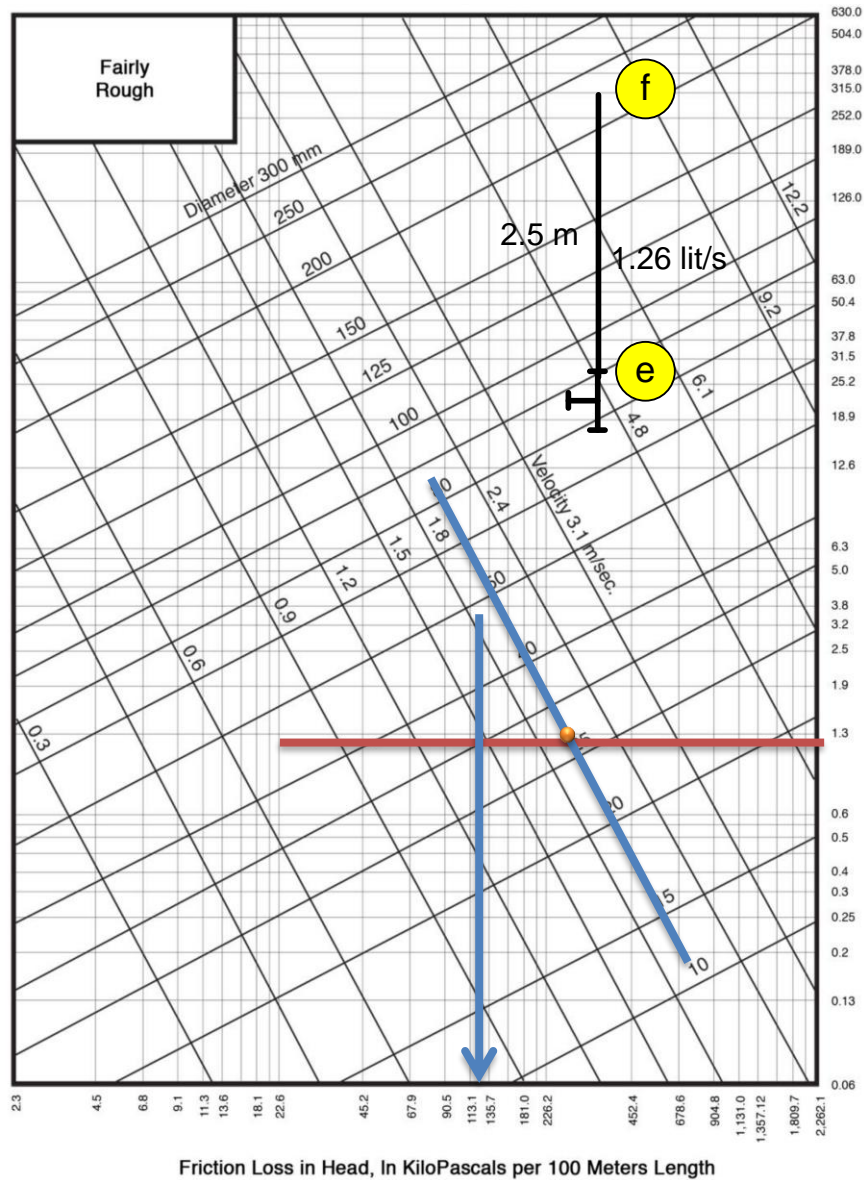

Flow in Liters per Second

Table (4) Fitting loss in equivalent (mm)

Nominal diameter Mm	Smooth bend elbows						Smooth bend Tee			
	90° Std	90° Long rad.	90° Street	45° Std	45° Street	180° Std.	Flow through branch	No reduction	Reduce d ¼	Reduce d ½
10	427	275	702	214	336	702	824	275	366	427
15	488	305	763	244	397	763	915	305	427	488
20	610	427	976	275	488	976	1220	427	580	610
25	793	519	1251	397	641	1251	1525	519	702	793
32	1007	702	1708	519	915	1708	2135	702	946	1007
40	1220	793	1922	641	1037	1922	2440	793	1129	1220
50	1525	1007	2501	793	1373	2501	3050	1007	1434	1525
65	1830	1220	3050	976	1586	3050	3660	1251	1708	1830
90	2745	1830	4575	1434	2227	4575	4575	1800	2440	2745
100	3050	2135	5185	1586	2593	5185	6405	2044	2745	3050
125	3965	2440	6405	1983	3355	6405	7625	2501	3660	3965
150	4880	3050	7625	2410	3965	7625	9150	3050	4270	4880

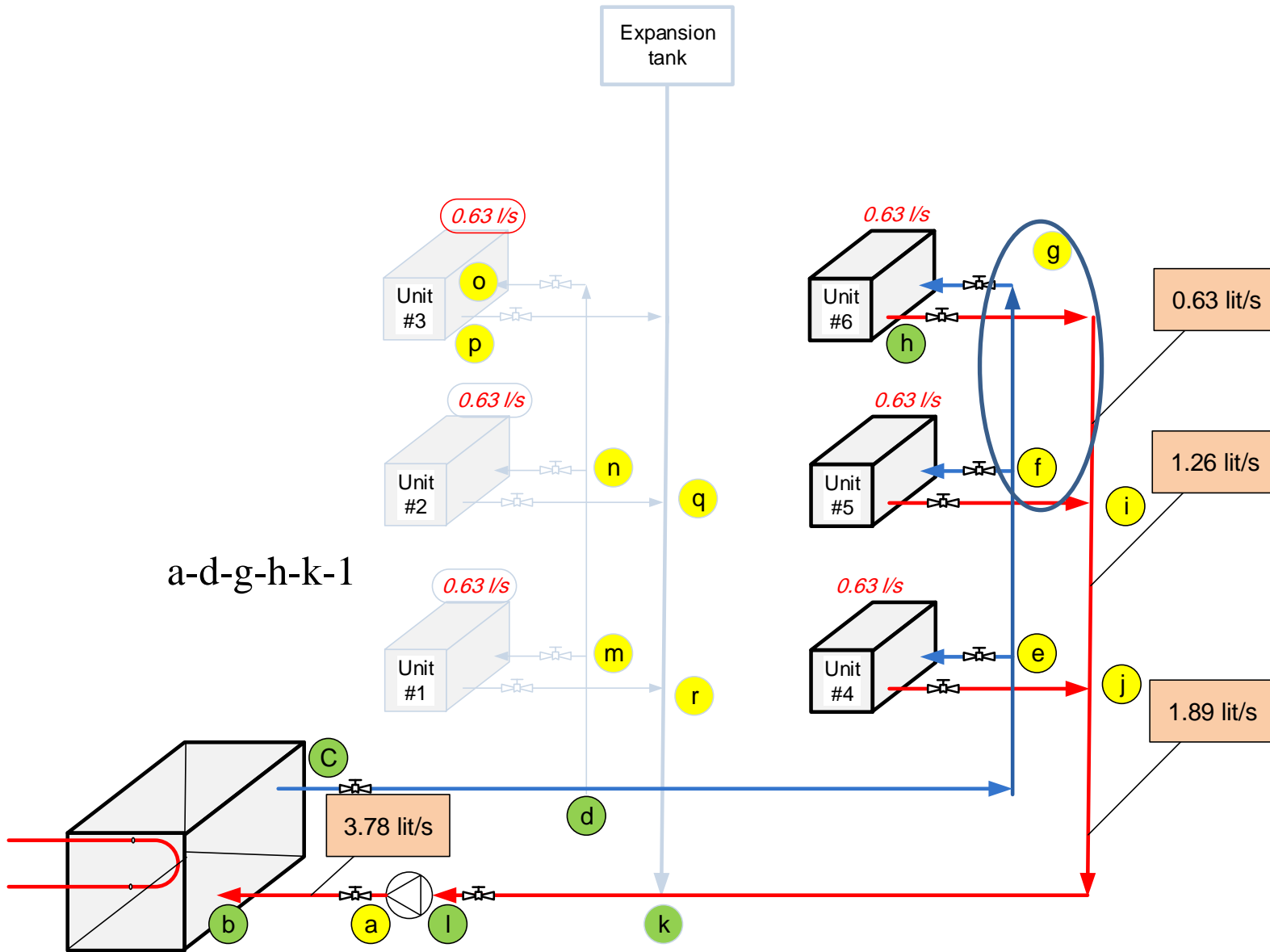

Run f-g: 0.63 lit/s, velocity 2 m/s

the pipe diameter is 25 mm, pressure drop is 137.7 kPa/100m

Pipe length = 4.5

Equiv. length due to side Tee through (table 4) is 0.519 m

Equiv. length due to 90° std. elbow (table 4) is 0.793 m

Equiv. length due to gate valve (table 3) is 0.305 m

Pressure drop = $(4.5 + 0.519 + 0.793 + 0.305) * (137.7 / 100) = 8.5$

Table (4) Fitting, loss in equivalent (mm)





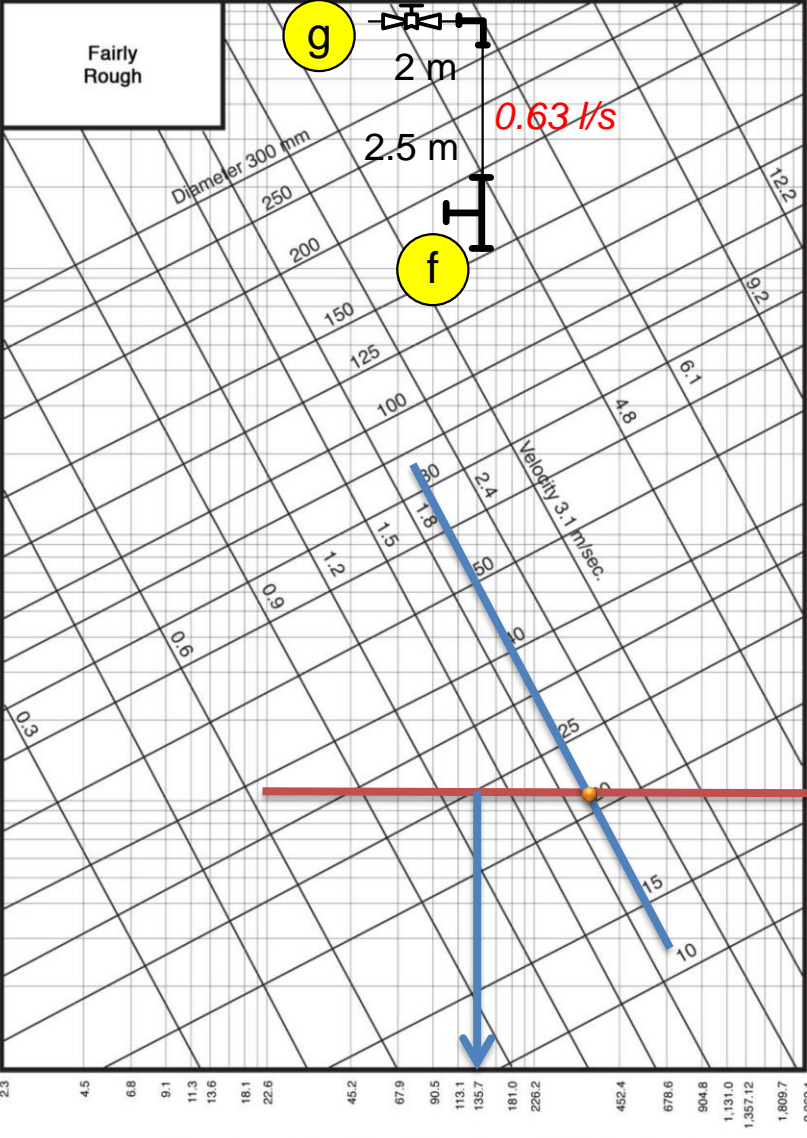

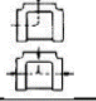



Table (3) Valve loss in equivalent (mm) length

Nominal diameter mm	Globe		Angle		Gate	Swing Check	Y type strainer	
	Angle		60° Y	45° Y			Flanged	Screwed end
	60°	45°			60°	45°		
10	5185	2440	1830	1830	183	1525	-----	-----
15	5490	2745	2135	2135	2135	1830	-----	915
20	6710	3355	2745	2745	275	2440	-----	1220
25	8845	4575	3660	3660	305	3050	-----	1525
32	11590	6100	4575	4575	458	4270	-----	2745
40	13115	7320	5490	5490	549	4880	-----	3050
50	16775	9150	7320	7320	702	6100	8235	4270
65	21045	10675	8845	8845	854	7625	8540	6100
80	30500	15250	12505	12505	1220	10675	14640	-----
100	36600	17690	14335	14335	1373	12200	18300	-----
125	42700	21655	17690	17690	1830	15250	24400	-----
150	51850	26840	21350	21350	2135	18300	33550	-----



Friction Loss in Head, In KiloPascals per 100 Meters Length

Table (4) Fitting ,loss in equivalent (mm)

Nominal diameter Mm	Smooth bend elbows						Smooth bend Tee			
	90° Std	90° Long rad.	90° Street	45° Std	45° Street	180° Std.	Flow through branch	No reduction	Reduce d ¼	Reduce d ½
										
10	427	275	702	214	336	702	824	275	366	427
15	488	305	763	244	397	763	915	305	427	488
20	610	427	976	275	488	976	1220	427	580	610
25	793	519	1251	397	641	1251	1525	519	702	793
32	1007	702	1708	519	915	1708	2135	702	946	1007
40	1220	793	1922	641	1037	1922	2440	793	1129	1220
50	1525	1007	2501	793	1373	2501	3050	1007	1434	1525
65	1830	1220	3050	976	1586	3050	3660	1251	1708	1830
90	2745	1830	4575	1434	2227	4575	4575	1800	2440	2745
100	3050	2135	5185	1586	2593	5185	6405	2044	2745	3050
125	3965	2440	6405	1983	3355	6405	7625	2501	3660	3965
150	4880	3050	7625	2410	3965	7625	9150	3050	4270	4880

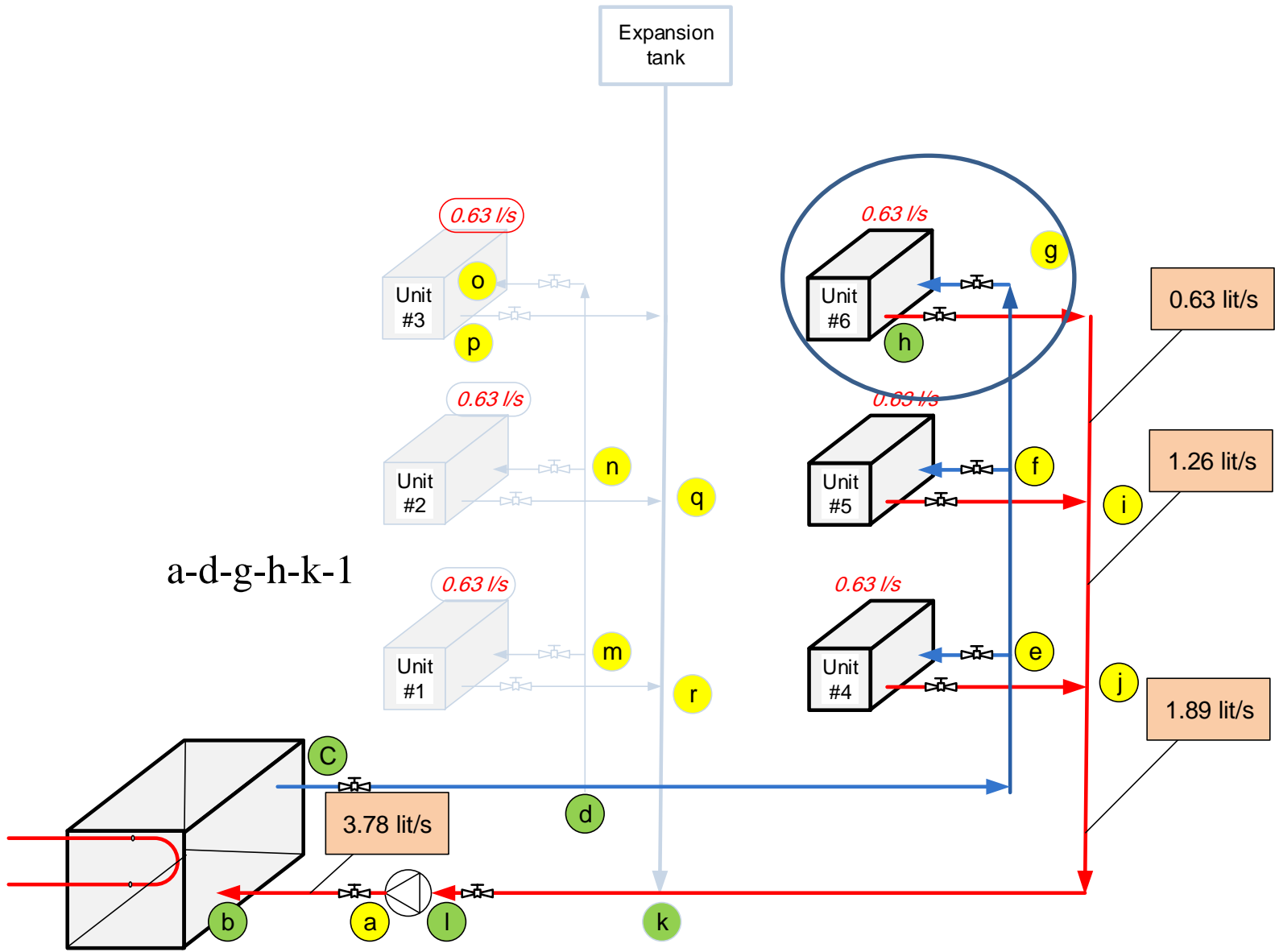

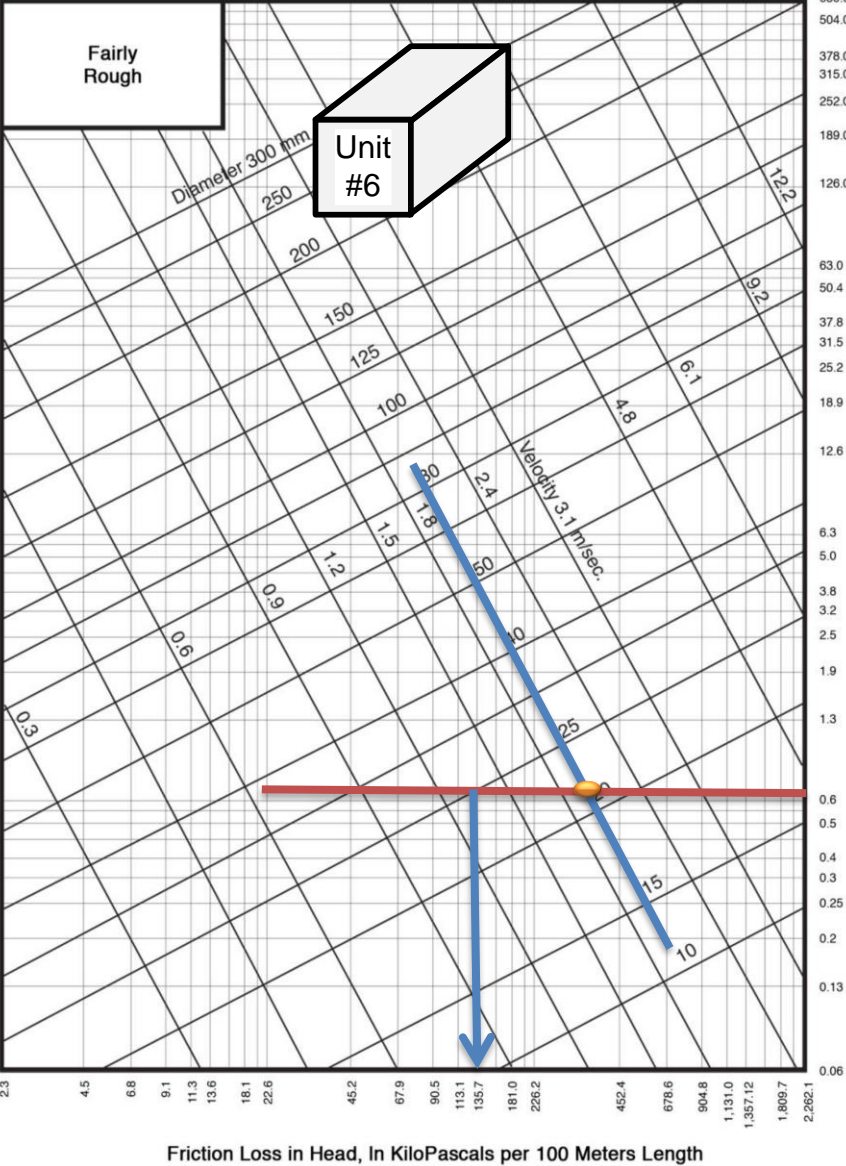

Run g-h: 3.5 m of water each unit condenser at 0.63 lit/s flow rate:

Pressure drop = $3.5 * (137.7 / 100) = 4.8$ kPa

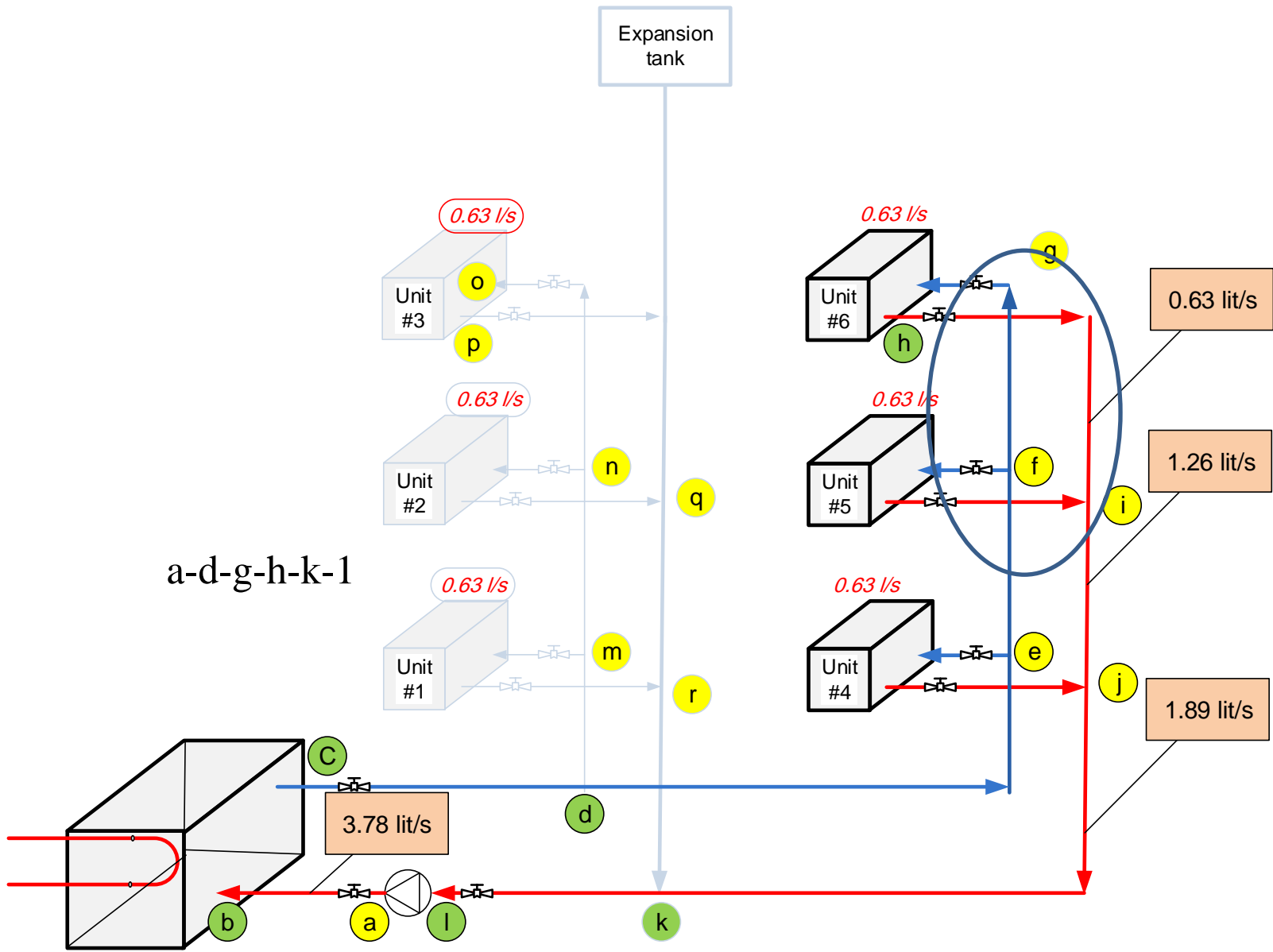

a-d-g-h-k-l

the pipe diameter is 25 mm, pressure drop is 137.7 kPa/100m

Pipe length = 4.5

Equiv. length due to side Tee through (table 4) is 0.519 m

Equiv. length due to 90° std. elbow (table 4) is 0.793 m

Equiv. length due to gate valve (table 3) is 0.305 m

Pressure drop = $(4.5 + 0.519 + 0.793 + 0.305) * (137.7 / 100) = 8.5 \text{ kPa}$

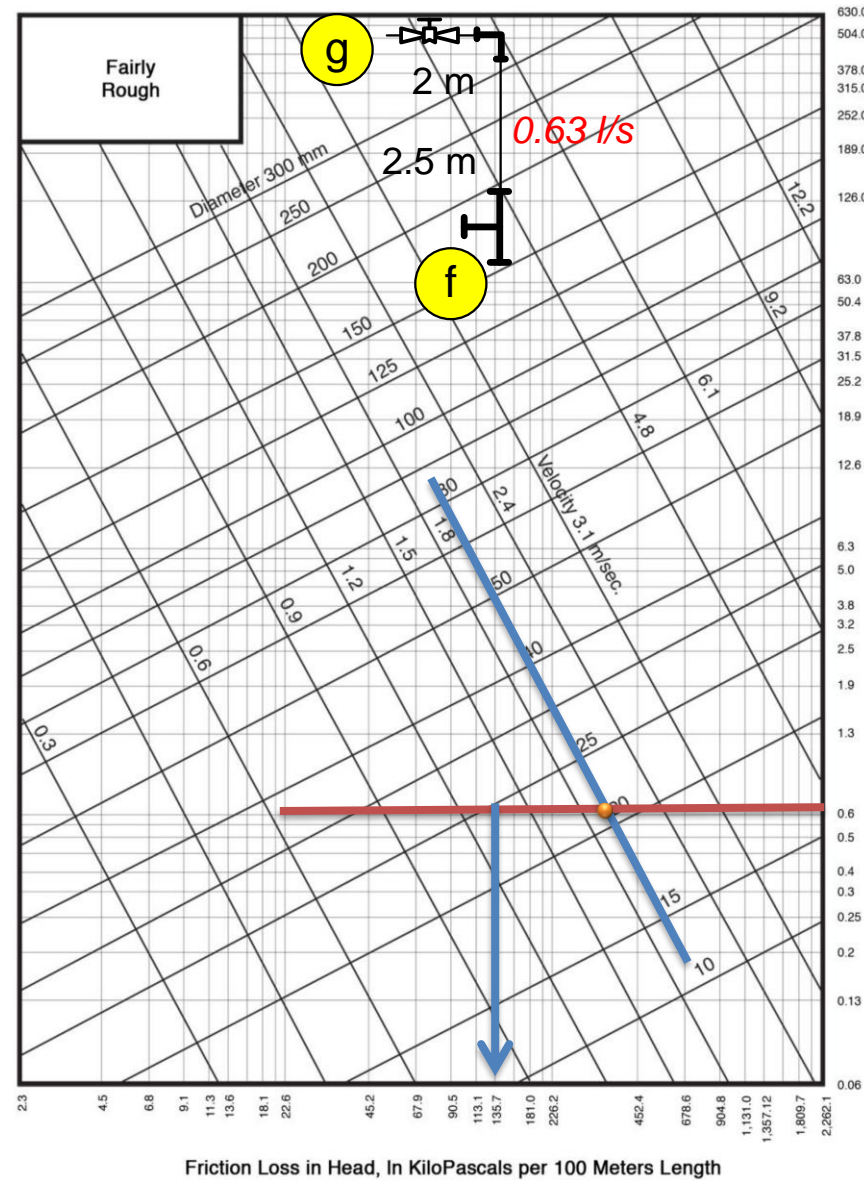











Table (3) Valve loss in equivalent (mm) length

Nominal diameter mm	Globe		Angle		Gate	Swing Check	Y type strainer	
			60° Y	45° Y			Flanged	Screwed end
	Globe	60° Y	45° Y	Angle				
10	5185	2440	1830	1830	183	1525	-----	-----
15	5490	2745	2135	2135	2135	1830	-----	915
20	6710	3355	2745	2745	275	2440	-----	1220
25	8845	4575	3660	3660	305	3050	-----	1525
32	11590	6100	4575	4575	458	4270	-----	2745
40	13115	7320	5490	5490	549	4880	-----	3050
50	16775	9150	7320	7320	702	6100	8235	4270
65	21045	10675	8845	8845	854	7625	8540	6100
80	30500	15250	12505	12505	1220	10675	14640	-----
100	36600	17690	14335	14335	1373	12200	18300	-----
125	42700	21655	17690	17690	1830	15250	24400	-----
150	51850	26840	21350	21350	2135	18300	33550	-----

Run h-l : 0.63 lit/s, velocity 2 m/s

Table (4) Fitting ,loss in equivalent (mm)

Nominal diameter Mm	Smooth bend elbows						Smooth bend Tee			
	90° Std	90° Long rad.	90° Street	45° Std	45° Street	180° Std.	Flow through branch	No reduction	Reduce d ¼	Reduce d ½
										
10	427	275	702	214	336	702	824	275	366	427
15	488	305	763	244	397	763	915	305	427	488
20	610	427	976	275	488	976	1220	427	580	610
25	793	519	1251	397	641	1251	1525	519	702	793
32	1007	702	1708	519	915	1708	2135	702	946	1007
40	1220	793	1922	641	1037	1922	2440	793	1129	1220
50	1525	1007	2501	793	1373	2501	3050	1007	1434	1525
65	1830	1220	3050	976	1586	3050	3660	1251	1708	1830
90	2745	1830	4575	1434	2227	4575	4575	1800	2440	2745
100	3050	2135	5185	1586	2593	5185	6405	2044	2745	3050
125	3965	2440	6405	1983	3355	6405	7625	2501	3660	3965
150	4880	3050	7625	2410	3965	7625	9150	3050	4270	4880

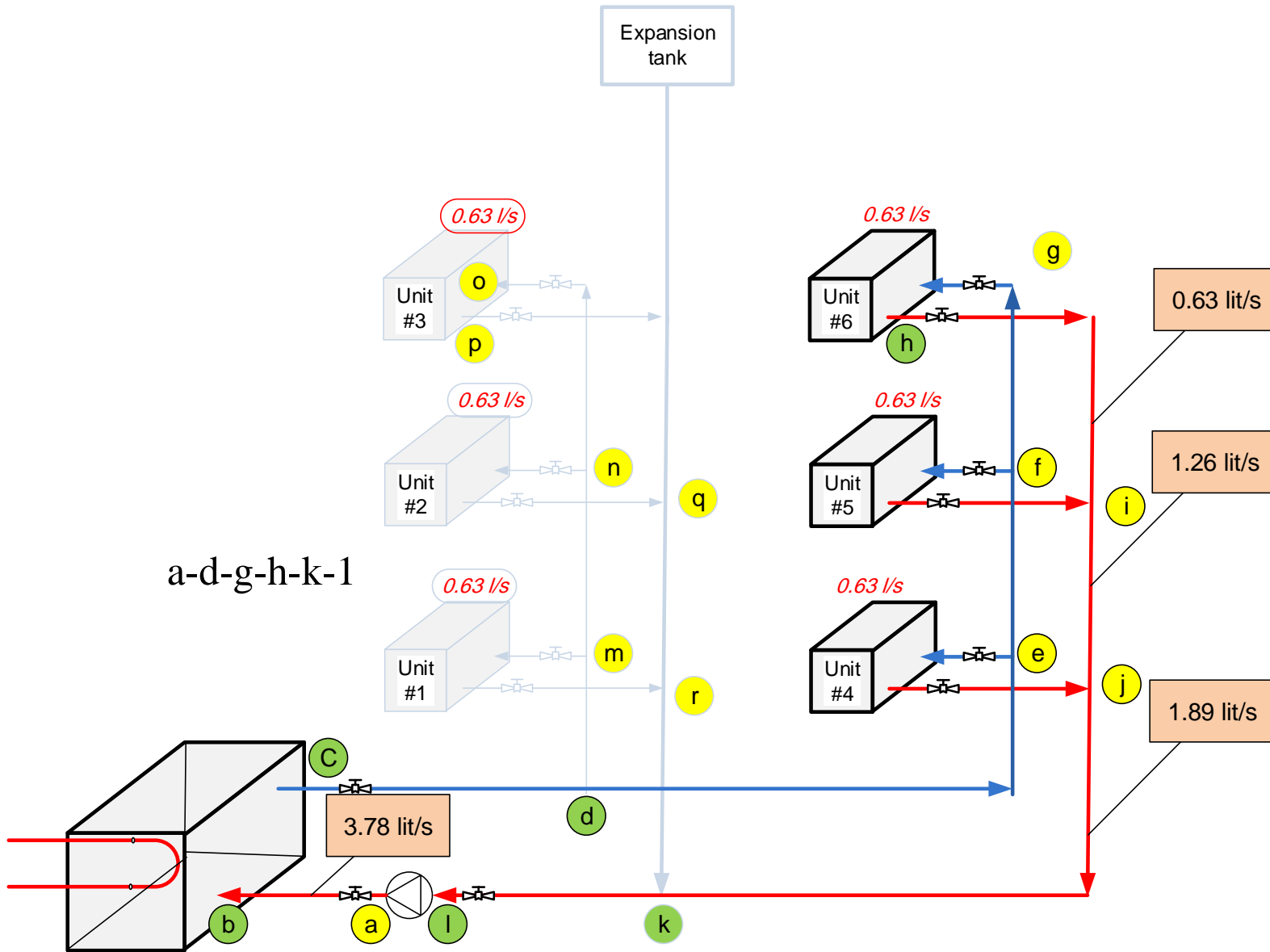

a-d-g-h-k-l

Runs	Lit/s	D mm	L m	Fitting equivalent length m				Total equiv. length	Press drop kPa./100 m	Total press. Drop kPa.	Actual press. drop
				Gate valve	Std. Tee through run	Std. Tee through branch	Std. 90° elbow				
a-b	3.78	50	0.92	0.702				1.622	101	1.7	a: 73
b-c	3.78	Heat exchanger						4.5		4.6	b:71.3
c-d	3.78	50	4.5	0.702				5.22	101	5.3	c:66.7
d-e	1.89	40	6.5		0.793		1.22	8.513	113	11.88	d:61.4
e-f	1.26	30	2.5		0.702			3.202	124.4	3.98	e:50.887
f-g	0.63	25	4.5	0.305	0.793		0.305	6.2	137.7	8.5	f:46.087
g-h	0.63	Unit #6						3.5	137.7	4.8	g:37.587
h-i	0.63	25	4.5	0.305	0.793		0.305	6.2	137.7	8.5	h:32.787
i-j	1.26	30	2.5		0.702			3.202	124.4	4.8	i:24.87
j-k	1.89	40	6.5		0.793		1.22	8.513	137.7	11.7	j:19.487
k-l	3.78	50	3.8	0.702		3.05		7.6	101	7.7	k:7.787
a-l										73.46	