

Torsional and Bending Stresses in Machine Parts

1. Introduction.
2. Torsional Shear Stress.
3. Shafts in Series and Parallel.
4. Bending Stress in Straight Beams.
5. Bending Stress in Curved Beams.
6. Principal Stresses and Principal Planes.
7. Determination of Principal Stresses for a Member Subjected to Biaxial Stress.
8. Application of Principal Stresses in Designing Machine Members.
9. Theories of Failure under Static Load.
10. Maximum Principal or Normal Stress Theory (Rankine's Theory).
11. Maximum Shear Stress Theory (Guest's or Tresca's Theory).
12. Maximum Principal Strain Theory (Saint Venant's Theory).
13. Maximum Strain Energy Theory (Haigh's Theory).
14. Maximum Distortion Energy Theory (Hencky and Von Mises Theory).
15. Eccentric Loading—Direct and Bending Stresses Combined.
16. Shear Stresses in Beams.



5.1 Introduction

Sometimes machine parts are subjected to pure torsion or bending or combination of both torsion and bending stresses. We shall now discuss these stresses in detail in the following pages.

5.2 Torsional Shear Stress

When a machine member is subjected to the action of two equal and opposite couples acting in parallel planes (or torque or twisting moment), then the machine member is said to be subjected to *torsion*. The stress set up by torsion is known as *torsional shear stress*. It is zero at the centroidal axis and maximum at the outer surface.

Consider a shaft fixed at one end and subjected to a torque (T) at the other end as shown in Fig. 5.1. As a result of this torque, every cross-section of the shaft is subjected to torsional shear stress. We have discussed above that the

torsional shear stress is zero at the centroidal axis and maximum at the outer surface. The maximum torsional shear stress at the outer surface of the shaft may be obtained from the following equation:

$$\frac{\tau}{r} = \frac{T}{J} = \frac{C \cdot \theta}{l} \quad \dots(i)$$

- where
- τ = Torsional shear stress induced at the outer surface of the shaft or maximum shear stress,
 - r = Radius of the shaft,
 - T = Torque or twisting moment,
 - J = Second moment of area of the section about its polar axis or polar moment of inertia,
 - C = Modulus of rigidity for the shaft material,
 - l = Length of the shaft, and
 - θ = Angle of twist in radians on a length l .

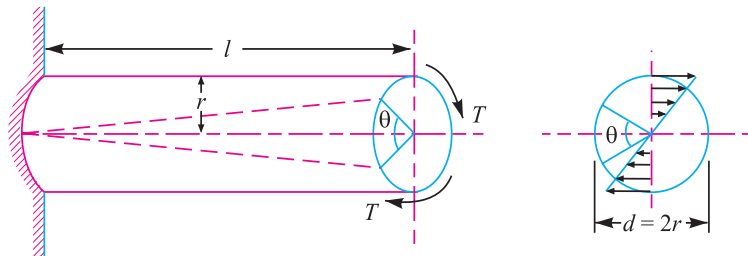

Fig. 5.1. Torsional shear stress.

The equation (i) is known as **torsion equation**. It is based on the following assumptions:

1. The material of the shaft is uniform throughout.
2. The twist along the length of the shaft is uniform.
3. The normal cross-sections of the shaft, which were plane and circular before twist, remain plane and circular after twist.
4. All diameters of the normal cross-section which were straight before twist, remain straight with their magnitude unchanged, after twist.
5. The maximum shear stress induced in the shaft due to the twisting moment does not exceed its elastic limit value.

Notes : 1. Since the torsional shear stress on any cross-section normal to the axis is directly proportional to the distance from the centre of the axis, therefore the torsional shear stress at a distance x from the centre of the shaft is given by

$$\frac{\tau_x}{x} = \frac{\tau}{r}$$

2. From equation (i), we know that

$$\frac{T}{J} = \frac{\tau}{r} \quad \text{or} \quad T = \tau \times \frac{J}{r}$$

For a solid shaft of diameter (d), the polar moment of inertia,

$$J = I_{XX} + I_{YY} = \frac{\pi}{64} \times d^4 + \frac{\pi}{64} \times d^4 = \frac{\pi}{32} \times d^4$$

$$\therefore T = \tau \times \frac{\pi}{32} \times d^4 \times \frac{2}{d} = \frac{\pi}{16} \times \tau \times d^3$$

122 ■ A Textbook of Machine Design

In case of a hollow shaft with external diameter (d_o) and internal diameter (d_i), the polar moment of inertia,

$$J = \frac{\pi}{32} [(d_o)^4 - (d_i)^4] \text{ and } r = \frac{d_o}{2}$$

$$\therefore T = \tau \times \frac{\pi}{32} [(d_o)^4 - (d_i)^4] \times \frac{2}{d_o} = \frac{\pi}{16} \times \tau \left[\frac{(d_o)^4 - (d_i)^4}{d_o} \right]$$

$$= \frac{\pi}{16} \times \tau (d_o)^3 (1 - k^4) \quad \dots \left(\text{Substituting, } k = \frac{d_i}{d_o} \right)$$

3. The expression ($C \times J$) is called **torsional rigidity** of the shaft.

4. The strength of the shaft means the maximum torque transmitted by it. Therefore, in order to design a shaft for strength, the above equations are used. The power transmitted by the shaft (in watts) is given by

$$P = \frac{2 \pi N \cdot T}{60} = T \cdot \omega \quad \dots \left(\because \omega = \frac{2 \pi N}{60} \right)$$

where

T = Torque transmitted in N-m, and

ω = Angular speed in rad/s.

Example 5.1. A shaft is transmitting 100 kW at 160 r.p.m. Find a suitable diameter for the shaft, if the maximum torque transmitted exceeds the mean by 25%. Take maximum allowable shear stress as 70 MPa.

Solution. Given : $P = 100 \text{ kW} = 100 \times 10^3 \text{ W}$; $N = 160 \text{ r.p.m}$; $T_{max} = 1.25 T_{mean}$; $\tau = 70 \text{ MPa} = 70 \text{ N/mm}^2$

Let T_{mean} = Mean torque transmitted by the shaft in N-m, and
 d = Diameter of the shaft in mm.

We know that the power transmitted (P),

$$100 \times 10^3 = \frac{2 \pi N \cdot T_{mean}}{60} = \frac{2 \pi \times 160 \times T_{mean}}{60} = 16.76 T_{mean}$$

$$\therefore T_{mean} = 100 \times 10^3 / 16.76 = 5966.6 \text{ N-m}$$



A Helicopter propeller shaft has to bear torsional, tensile, as well as bending stresses.

Note : This picture is given as additional information and is not a direct example of the current chapter.

and maximum torque transmitted,

$$T_{max} = 1.25 \times 5966.6 = 7458 \text{ N-m} = 7458 \times 10^3 \text{ N-mm}$$

We know that maximum torque (T_{max}),

$$7458 \times 10^3 = \frac{\pi}{16} \times \tau \times d^3 = \frac{\pi}{16} \times 70 \times d^3 = 13.75 d^3$$

$$\therefore d^3 = 7458 \times 10^3 / 13.75 = 542.4 \times 10^3 \text{ or } d = 81.5 \text{ mm Ans.}$$

Example 5.2. A steel shaft 35 mm in diameter and 1.2 m long held rigidly at one end has a hand wheel 500 mm in diameter keyed to the other end. The modulus of rigidity of steel is 80 GPa.

1. What load applied to tangent to the rim of the wheel produce a torsional shear of 60 MPa?
2. How many degrees will the wheel turn when this load is applied?

Solution. Given : $d = 35 \text{ mm}$ or $r = 17.5 \text{ mm}$; $l = 1.2 \text{ m} = 1200 \text{ mm}$; $D = 500 \text{ mm}$ or $R = 250 \text{ mm}$; $C = 80 \text{ GPa} = 80 \text{ kN/mm}^2 = 80 \times 10^3 \text{ N/mm}^2$; $\tau = 60 \text{ MPa} = 60 \text{ N/mm}^2$

1. Load applied to the tangent to the rim of the wheel

Let $W =$ Load applied (in newton) to tangent to the rim of the wheel.

We know that torque applied to the hand wheel,

$$T = W.R = W \times 250 = 250 W \text{ N-mm}$$

and polar moment of inertia of the shaft,

$$J = \frac{\pi}{32} \times d^4 = \frac{\pi}{32} (35)^4 = 147.34 \times 10^3 \text{ mm}^4$$

We know that $\frac{T}{J} = \frac{\tau}{r}$

$$\therefore \frac{250 W}{147.34 \times 10^3} = \frac{60}{17.5} \text{ or } W = \frac{60 \times 147.34 \times 10^3}{17.5 \times 250} = 2020 \text{ N Ans.}$$

2. Number of degrees which the wheel will turn when load $W = 2020 \text{ N}$ is applied

Let $\theta =$ Required number of degrees.

We know that $\frac{T}{J} = \frac{C.\theta}{l}$

$$\therefore \theta = \frac{T.l}{C.J} = \frac{250 \times 2020 \times 1200}{80 \times 10^3 \times 147.34 \times 10^3} = 0.05^\circ \text{ Ans.}$$

Example 5.3. A shaft is transmitting 97.5 kW at 180 r.p.m. If the allowable shear stress in the material is 60 MPa, find the suitable diameter for the shaft. The shaft is not to twist more than 1° in a length of 3 metres. Take $C = 80 \text{ GPa}$.

Solution. Given : $P = 97.5 \text{ kW} = 97.5 \times 10^3 \text{ W}$; $N = 180 \text{ r.p.m.}$; $\tau = 60 \text{ MPa} = 60 \text{ N/mm}^2$; $\theta = 1^\circ = \pi / 180 = 0.0174 \text{ rad}$; $l = 3 \text{ m} = 3000 \text{ mm}$; $C = 80 \text{ GPa} = 80 \times 10^9 \text{ N/m}^2 = 80 \times 10^3 \text{ N/mm}^2$

Let $T =$ Torque transmitted by the shaft in N-m, and

$d =$ Diameter of the shaft in mm.

We know that the power transmitted by the shaft (P),

$$97.5 \times 10^3 = \frac{2 \pi N.T}{60} = \frac{2\pi \times 180 \times T}{60} = 18.852 T$$

$$\therefore T = 97.5 \times 10^3 / 18.852 = 5172 \text{ N-m} = 5172 \times 10^3 \text{ N-mm}$$

Now let us find the diameter of the shaft based on the strength and stiffness.

124 ■ A Textbook of Machine Design

1. Considering strength of the shaft

We know that the torque transmitted (T),

$$5172 \times 10^3 = \frac{\pi}{16} \times \tau \times d^3 = \frac{\pi}{16} \times 60 \times d^3 = 11.78 d^3$$

$$\therefore d^3 = 5172 \times 10^3 / 11.78 = 439 \times 10^3 \text{ or } d = 76 \text{ mm} \quad \dots(i)$$

2. Considering stiffness of the shaft

Polar moment of inertia of the shaft,

$$J = \frac{\pi}{32} \times d^4 = 0.0982 d^4$$

We know that $\frac{T}{J} = \frac{C \cdot \theta}{l}$

$$\frac{5172 \times 10^3}{0.0982 d^4} = \frac{80 \times 10^3 \times 0.0174}{3000} \text{ or } \frac{52.7 \times 10^6}{d^4} = 0.464$$

$$\therefore d^4 = 52.7 \times 10^6 / 0.464 = 113.6 \times 10^6 \text{ or } d = 103 \text{ mm} \quad \dots(ii)$$

Taking larger of the two values, we shall provide $d = 103$ say 105 mm **Ans.**

Example 5.4. A hollow shaft is required to transmit 600 kW at 110 r.p.m., the maximum torque being 20% greater than the mean. The shear stress is not to exceed 63 MPa and twist in a length of 3 metres not to exceed 1.4 degrees. Find the external diameter of the shaft, if the internal diameter to the external diameter is 3/8. Take modulus of rigidity as 84 GPa.

Solution. Given : $P = 600 \text{ kW} = 600 \times 10^3 \text{ W}$; $N = 110 \text{ r.p.m.}$; $T_{max} = 1.2 T_{mean}$; $\tau = 63 \text{ MPa} = 63 \text{ N/mm}^2$; $l = 3 \text{ m} = 3000 \text{ mm}$; $\theta = 1.4 \times \pi / 180 = 0.024 \text{ rad}$; $k = d_i / d_o = 3/8$; $C = 84 \text{ GPa} = 84 \times 10^9 \text{ N/m}^2 = 84 \times 10^3 \text{ N/mm}^2$

Let T_{mean} = Mean torque transmitted by the shaft,
 d_o = External diameter of the shaft, and
 d_i = Internal diameter of the shaft.

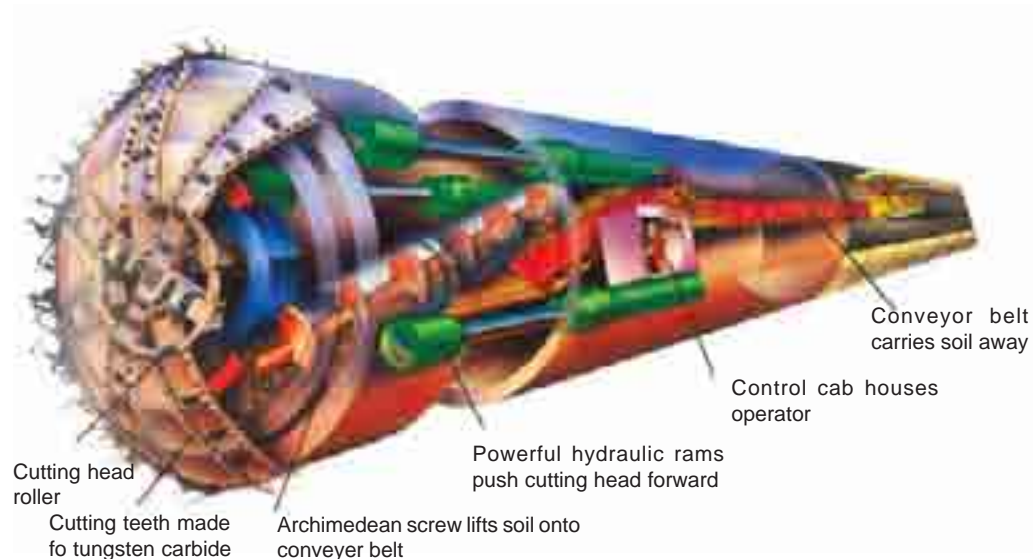

A tunnel-boring machine can cut through rock at up to one kilometre a month. Powerful hydraulic rams force the machine's cutting head forwards as the rock is cut away.

Note : This picture is given as additional information and is not a direct example of the current chapter.

We know that power transmitted by the shaft (P),

$$600 \times 10^3 = \frac{2 \pi N . T_{mean}}{60} = \frac{2 \pi \times 110 \times T_{mean}}{60} = 11.52 T_{mean}$$

$$\therefore T_{mean} = 600 \times 10^3 / 11.52 = 52 \times 10^3 \text{ N-m} = 52 \times 10^6 \text{ N-mm}$$

and maximum torque transmitted by the shaft,

$$T_{max} = 1.2 T_{mean} = 1.2 \times 52 \times 10^6 = 62.4 \times 10^6 \text{ N-mm}$$

Now let us find the diameter of the shaft considering strength and stiffness.

1. Considering strength of the shaft

We know that maximum torque transmitted by the shaft,

$$T_{max} = \frac{\pi}{16} \times \tau (d_o)^3 (1 - k^4)$$

$$62.4 \times 10^6 = \frac{\pi}{16} \times 63 \times (d_o)^3 \left[1 - \left(\frac{3}{8} \right)^4 \right] = 12.12 (d_o)^3$$

$$\therefore (d_o)^3 = 62.4 \times 10^6 / 12.12 = 5.15 \times 10^6 \text{ or } d_o = 172.7 \text{ mm} \quad \dots(i)$$

2. Considering stiffness of the shaft

We know that polar moment of inertia of a hollow circular section,

$$\begin{aligned} J &= \frac{\pi}{32} [(d_o)^4 - (d_i)^4] = \frac{\pi}{32} (d_o)^4 \left[1 - \left(\frac{d_i}{d_o} \right)^4 \right] \\ &= \frac{\pi}{32} (d_o)^4 (1 - k^4) = \frac{\pi}{32} (d_o)^4 \left[1 - \left(\frac{3}{8} \right)^4 \right] = 0.0962 (d_o)^4 \end{aligned}$$

We also know that

$$\frac{T}{J} = \frac{C . \theta}{l}$$

$$\frac{62.4 \times 10^6}{0.0962 (d_o)^4} = \frac{84 \times 10^3 \times 0.024}{3000} \text{ or } \frac{648.6 \times 10^6}{(d_o)^4} = 0.672$$

$$\therefore (d_o)^4 = 648.6 \times 10^6 / 0.672 = 964 \times 10^6 \text{ or } d_o = 176.2 \text{ mm} \quad \dots(ii)$$

Taking larger of the two values, we shall provide

$$d_o = 176.2 \text{ say } 180 \text{ mm Ans.}$$

5.3 Shafts in Series and Parallel

When two shafts of different diameters are connected together to form one shaft, it is then known as **composite shaft**. If the driving torque is applied at one end and the resisting torque at the other end, then the shafts are said to be connected in series as shown in Fig. 5.2 (a). In such cases, each shaft transmits the same torque and the total angle of twist is equal to the sum of the angle of twists of the two shafts.

Mathematically, total angle of twist,

$$\theta = \theta_1 + \theta_2 = \frac{T . l_1}{C_1 J_1} + \frac{T . l_2}{C_2 J_2}$$

If the shafts are made of the same material, then $C_1 = C_2 = C$.

$$\therefore \theta = \frac{T . l_1}{C J_1} + \frac{T . l_2}{C J_2} = \frac{T}{C} \left[\frac{l_1}{J_1} + \frac{l_2}{J_2} \right]$$

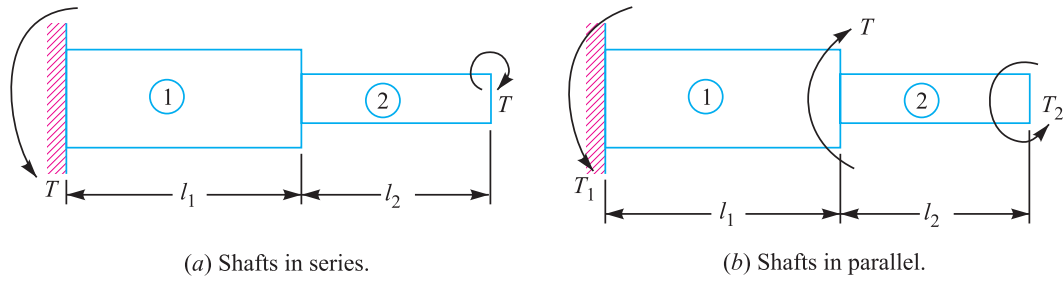

Fig. 5.2. Shafts in series and parallel.

When the driving torque (T) is applied at the junction of the two shafts, and the resisting torques T_1 and T_2 at the other ends of the shafts, then the shafts are said to be connected in parallel, as shown in Fig. 5.2 (b). In such cases, the angle of twist is same for both the shafts, *i.e.*

$$\theta_1 = \theta_2$$

or

$$\frac{T_1 l_1}{C_1 J_1} = \frac{T_2 l_2}{C_2 J_2} \quad \text{or} \quad \frac{T_1}{T_2} = \frac{l_2}{l_1} \times \frac{C_1}{C_2} \times \frac{J_1}{J_2}$$

and

$$T = T_1 + T_2$$

If the shafts are made of the same material, then $C_1 = C_2$.

$$\therefore \frac{T_1}{T_2} = \frac{l_2}{l_1} \times \frac{J_1}{J_2}$$

Example 5.5. A steel shaft ABCD having a total length of 3.5 m consists of three lengths having different sections as follows:

AB is hollow having outside and inside diameters of 100 mm and 62.5 mm respectively, and BC and CD are solid. BC has a diameter of 100 mm and CD has a diameter of 87.5 mm. If the angle of twist is the same for each section, determine the length of each section. Find the value of the applied torque and the total angle of twist, if the maximum shear stress in the hollow portion is 47.5 MPa and shear modulus, $C = 82.5$ GPa.

Solution. Given: $L = 3.5$ m ; $d_o = 100$ mm ; $d_i = 62.5$ mm ; $d_2 = 100$ mm ; $d_3 = 87.5$ mm ; $\tau = 47.5$ MPa = 47.5 N/mm² ; $C = 82.5$ GPa = 82.5 × 10³ N/mm²

The shaft ABCD is shown in Fig. 5.3.

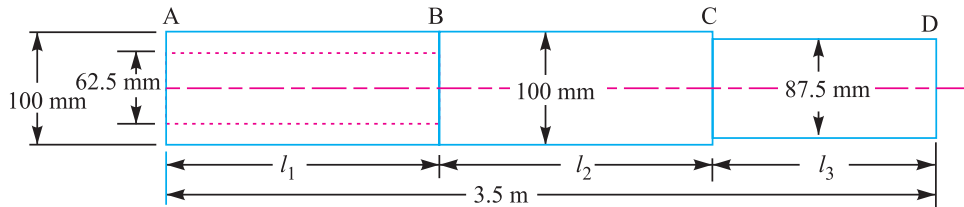

Fig. 5.3

Length of each section

Let l_1 , l_2 and l_3 = Length of sections AB, BC and CD respectively.

We know that polar moment of inertia of the hollow shaft AB,

$$J_1 = \frac{\pi}{32} [(d_o)^4 - (d_i)^4] = \frac{\pi}{32} [(100)^4 - (62.5)^4] = 8.32 \times 10^6 \text{ mm}^4$$

Polar moment of inertia of the solid shaft BC,

$$J_2 = \frac{\pi}{32} (d_2)^4 = \frac{\pi}{32} (100)^4 = 9.82 \times 10^6 \text{ mm}^4$$

and polar moment of inertia of the solid shaft CD ,

$$J_3 = \frac{\pi}{32} (d_3)^4 = \frac{\pi}{32} (87.5)^4 = 5.75 \times 10^6 \text{ mm}^4$$

We also know that angle of twist,

$$\theta = T \cdot l / C \cdot J$$

Assuming the torque T and shear modulus C to be same for all the sections, we have

Angle of twist for hollow shaft AB ,

$$\theta_1 = T \cdot l_1 / C \cdot J_1$$

Similarly, angle of twist for solid shaft BC ,

$$\theta_2 = T \cdot l_2 / C \cdot J_2$$

and angle of twist for solid shaft CD ,

$$\theta_3 = T \cdot l_3 / C \cdot J_3$$

Since the angle of twist is same for each section, therefore

$$\theta_1 = \theta_2$$

$$\frac{T \cdot l_1}{C \cdot J_1} = \frac{T \cdot l_2}{C \cdot J_2} \text{ or } \frac{l_1}{l_2} = \frac{J_1}{J_2} = \frac{8.32 \times 10^6}{9.82 \times 10^6} = 0.847 \quad \dots(i)$$

Also

$$\theta_1 = \theta_3$$

$$\frac{T \cdot l_1}{C \cdot J_1} = \frac{T \cdot l_3}{C \cdot J_3} \text{ or } \frac{l_1}{l_3} = \frac{J_1}{J_3} = \frac{8.32 \times 10^6}{5.75 \times 10^6} = 1.447 \quad \dots(ii)$$

We know that $l_1 + l_2 + l_3 = L = 3.5 \text{ m} = 3500 \text{ mm}$

$$l_1 \left(1 + \frac{l_2}{l_1} + \frac{l_3}{l_1} \right) = 3500$$

$$l_1 \left(1 + \frac{1}{0.847} + \frac{1}{1.447} \right) = 3500$$

$$l_1 \times 2.8717 = 3500 \text{ or } l_1 = 3500 / 2.8717 = 1218.8 \text{ mm Ans.}$$

From equation (i),

$$l_2 = l_1 / 0.847 = 1218.8 / 0.847 = 1439 \text{ mm Ans.}$$

and from equation (ii),

$$l_3 = l_1 / 1.447 = 1218.8 / 1.447 = 842.2 \text{ mm Ans.}$$

Value of the applied torque

We know that the maximum shear stress in the hollow portion,

$$\tau = 47.5 \text{ MPa} = 47.5 \text{ N/mm}^2$$

For a hollow shaft, the applied torque,

$$T = \frac{\pi}{16} \times \tau \left[\frac{(d_o)^4 - (d_i)^4}{d_o} \right] = \frac{\pi}{16} \times 47.5 \left[\frac{(100)^4 - (62.5)^4}{100} \right]$$

$$= 7.9 \times 10^6 \text{ N-mm} = 7900 \text{ N-m Ans.}$$

Total angle of twist

When the shafts are connected in series, the total angle of twist is equal to the sum of angle of twists of the individual shafts. Mathematically, the total angle of twist,

$$\theta = \theta_1 + \theta_2 + \theta_3$$



Machine part of a jet engine.

Note : This picture is given as additional information and is not a direct example of the current chapter.

$$\begin{aligned}
 &= \frac{T \cdot l_1}{C \cdot J_1} + \frac{T \cdot l_2}{C \cdot J_2} + \frac{T \cdot l_3}{C \cdot J_3} = \frac{T}{C} \left[\frac{l_1}{J_1} + \frac{l_2}{J_2} + \frac{l_3}{J_3} \right] \\
 &= \frac{7.9 \times 10^6}{82.5 \times 10^3} \left[\frac{1218.8}{8.32 \times 10^6} + \frac{1439}{9.82 \times 10^6} + \frac{842.2}{5.75 \times 10^6} \right] \\
 &= \frac{7.9 \times 10^6}{82.5 \times 10^3 \times 10^6} [146.5 + 146.5 + 146.5] = 0.042 \text{ rad} \\
 &= 0.042 \times 180 / \pi = 2.406^\circ \text{ Ans.}
 \end{aligned}$$

5.4 Bending Stress in Straight Beams

In engineering practice, the machine parts of structural members may be subjected to static or dynamic loads which cause bending stress in the sections besides other types of stresses such as tensile, compressive and shearing stresses.

Consider a straight beam subjected to a bending moment M as shown in Fig. 5.4. The following assumptions are usually made while deriving the bending formula.

1. The material of the beam is perfectly homogeneous (*i.e.* of the same material throughout) and isotropic (*i.e.* of equal elastic properties in all directions).
2. The material of the beam obeys Hooke's law.
3. The transverse sections (*i.e.* BC or GH) which were plane before bending, remain plane after bending also.
4. Each layer of the beam is free to expand or contract, independently, of the layer, above or below it.
5. The Young's modulus (E) is the same in tension and compression.
6. The loads are applied in the plane of bending.

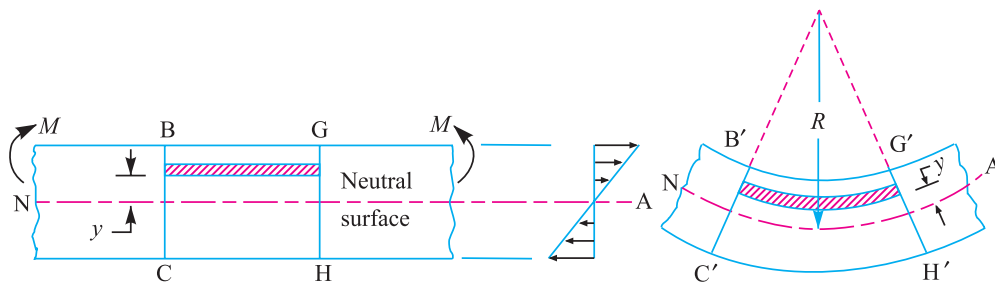

Fig. 5.4. Bending stress in straight beams.

A little consideration will show that when a beam is subjected to the bending moment, the fibres on the upper side of the beam will be shortened due to compression and those on the lower side will be elongated due to tension. It may be seen that somewhere between the top and bottom fibres there is a surface at which the fibres are neither shortened nor lengthened. Such a surface is called **neutral surface**. The intersection of the neutral surface with any normal cross-section of the beam is known as **neutral axis**. The stress distribution of a beam is shown in Fig. 5.4. The bending equation is given by

$$\frac{M}{I} = \frac{\sigma}{y} = \frac{E}{R}$$

where

M = Bending moment acting at the given section,

σ = Bending stress,

I = Moment of inertia of the cross-section about the neutral axis,
 y = Distance from the neutral axis to the extreme fibre,
 E = Young's modulus of the material of the beam, and
 R = Radius of curvature of the beam.

From the above equation, the bending stress is given by

$$\sigma = y \times \frac{E}{R}$$

Since E and R are constant, therefore within elastic limit, the stress at any point is directly proportional to y , *i.e.* the distance of the point from the neutral axis.

Also from the above equation, the bending stress,

$$\sigma = \frac{M}{I} \times y = \frac{M}{I/y} = \frac{M}{Z}$$

The ratio I/y is known as **section modulus** and is denoted by Z .

Notes : 1. The neutral axis of a section always passes through its centroid.

2. In case of symmetrical sections such as circular, square or rectangular, the neutral axis passes through its geometrical centre and the distance of extreme fibre from the neutral axis is $y = d/2$, where d is the diameter in case of circular section or depth in case of square or rectangular section.

3. In case of unsymmetrical sections such as L-section or T-section, the neutral axis does not pass through its geometrical centre. In such cases, first of all the centroid of the section is calculated and then the distance of the extreme fibres for both lower and upper side of the section is obtained. Out of these two values, the bigger value is used in bending equation.



Parts in a machine.

Table 5.1 (from pages 130 to 134) shows the properties of some common cross-sections.



This is the first revolver produced in a production line using interchangeable parts.

Note : This picture is given as additional information and is not a direct example of the current chapter.

Table 5.1. Properties of commonly used cross-sections.

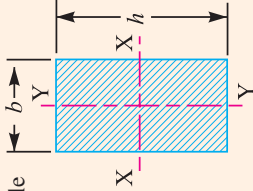
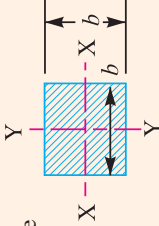
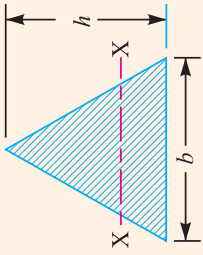
Section	Area (A)	Moment of inertia (I)	*Distance from the neutral axis to the extreme fibre (y)	Section modulus $\left[Z = \frac{I}{y} \right]$	Radius of gyration $\left[k = \sqrt{\frac{I}{A}} \right]$
1. Rectangle 	bh	$I_{xx} = \frac{bh^3}{12}$ $I_{yy} = \frac{hb^3}{12}$	$\frac{h}{2}$ $\frac{b}{2}$	$Z_{xx} = \frac{bh^2}{6}$ $Z_{yy} = \frac{hb^2}{6}$	$k_{xx} = 0.289 h$ $k_{yy} = 0.289 b$
2. Square 	b^2	$I_{xx} = I_{yy} = \frac{b^4}{12}$	$\frac{b}{2}$	$Z_{xx} = Z_{yy} = \frac{b^3}{6}$	$k_{xx} = k_{yy} = 0.289 b$
3. Triangle 	$\frac{bh}{2}$	$I_{xx} = \frac{bh^3}{36}$	$\frac{h}{3}$	$Z_{xx} = \frac{bh^2}{12}$	$k_{xx} = 0.2358 h$

* The distances from the neutral axis to the bottom extreme fibre is taken into consideration.

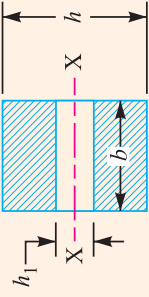
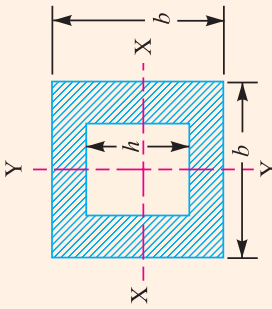
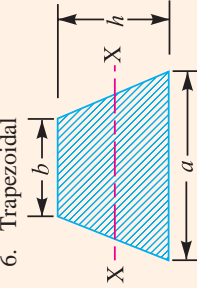
Section	(A)	(I)	(y)	$Z = \frac{I}{y}$	$k = \sqrt{\frac{I}{A}}$
4. Hollow rectangle 	$b(h - h_1)$	$I_{xx} = \frac{b}{12}(h^3 - h_1^3)$	$\frac{h}{2}$	$Z_{xx} = \frac{b}{6} \left(\frac{h^3 - h_1^3}{h} \right)$	$k_{xx} = 0.289 \sqrt{\frac{h^3 - h_1^3}{h - h_1}}$
5. Hollow square 	$b^2 - h^2$	$I_{xx} = I_{yy} = \frac{b^4 - h^4}{12}$	$\frac{b}{2}$	$Z_{xx} = Z_{yy} = \frac{b^4 - h^4}{6b}$	$0.289 \sqrt{b^2 + h^2}$
6. Trapezoidal 	$\frac{a + b}{2} \times h$	$I_{xx} = \frac{h^2 (a^2 + 4ab + b^2)}{36(a + b)}$	$\frac{a + 2b}{3(a + b)} \times h$	$Z_{xx} = \frac{a^2 + 4ab + b^2}{12(a + 2b)}$	$\frac{0.236}{a + b} \sqrt{h(a^2 + 4ab + b^2)}$

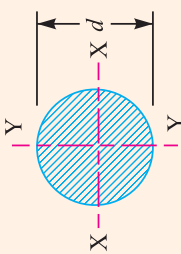
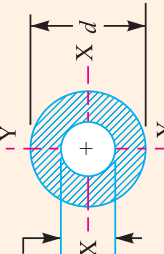
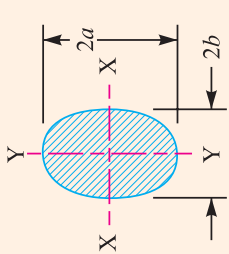
Section	(A)	(I)	(y)	$Z = \frac{I}{y}$	$k = \sqrt{\frac{I}{A}}$
7. Circle 	$\frac{\pi}{4} d^2$	$I_{xx} = I_{yy} = \frac{\pi d^4}{64}$	$\frac{d}{2}$	$Z_{xx} = Z_{yy} = \frac{\pi d^3}{32}$	$k_{xx} = k_{yy} = \frac{d}{2}$
8. Hollow circle 	$\frac{\pi}{4} (d^2 - d_1^2)$	$I_{xx} = I_{yy} = \frac{\pi}{64} (d^4 - d_1^4)$	$\frac{d}{2}$	$Z_{xx} = Z_{yy} = \frac{\pi}{32} \left(\frac{d^4 - d_1^4}{d} \right)$	$k_{xx} = k_{yy} = \frac{\sqrt{d^2 + d_1^2}}{4}$
9. Elliptical 	πab	$I_{xx} = \frac{\pi}{4} \times a^3 b$ $I_{yy} = \frac{\pi}{4} \times ab^3$	a b	$Z_{xx} = \frac{\pi}{4} \times a^2 b$ $Z_{yy} = \frac{\pi}{4} \times ab^2$	$k_{xx} = 0.5a$ $k_{yy} = 0.5b$

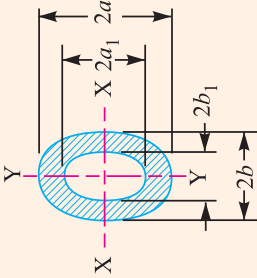
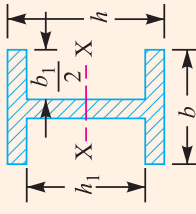
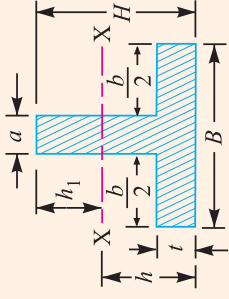
Section	(A)	(I)	(y)	$Z = \frac{I}{y}$	$k = \sqrt{\frac{I}{A}}$
10. Hollow elliptical 	$\pi (ab - a_1 b_1)$	$I_{xx} = \frac{\pi}{4} (ba^3 - b_1 a_1^3)$ $I_{yy} = \frac{\pi}{4} (ab^3 - a_1 b_1^3)$	a b	$Z_{xx} = \frac{\pi}{4a} (ba^3 - b_1 a_1^3)$ $Z_{yy} = \frac{\pi}{4b} (ab^3 - a_1 b_1^3)$	$k_{xx} = \frac{1}{2} \sqrt{\frac{ba^3 - b_1 a_1^3}{ab - a_1 b_1}}$ $k_{yy} = \frac{1}{2} \sqrt{\frac{ab^3 - a_1 b_1^3}{ab - a_1 b_1}}$
11. I-section 	$bh - b_1 h_1$	$I_{xx} = \frac{bt^3 - b_1 h_1^3}{12}$	$\frac{h}{2}$	$Z_{xx} = \frac{bt^3 - b_1 h_1^3}{6h}$	$k_{xx} = 0.289 \sqrt{\frac{bt^3 - b_1 h_1^3}{bt - b_1 h_1}}$
12. T-section 	$Bt + (H - t) a$	$I_{xx} = \frac{Bt^3 - b(h-t)^3 + ah_1^3}{3}$	$h = H - h_1$ $= \frac{aH^2 + bt^2}{2(aH + bt)}$	$Z_{xx} = \frac{2I_{xx}(aH + bt)}{aH^2 + bt^2}$	$k_{xx} = \sqrt{\frac{I_{xx}}{Bt + (H - t) a}}$

Section	(A)	(I)	(y)	$Z = \frac{I}{y}$	$k = \sqrt{\frac{I}{A}}$
<p>13. Channel Section</p>	$Bt + (H - t)a$	$I_{xx} = \frac{Bt^3 - b(h-t)^3 + ah_1^3}{3}$	$h = H - h_1 = \frac{aH^2 + bt^2}{2(aH + bt)}$	$Z_{xx} = \frac{2I_{xx}(aH + bt)}{aH^2 + bt^2}$	$k_{xx} = \sqrt{\frac{I_{xx}}{Bt + (H - t)a}}$
<p>14. H-Section</p>	$BH + bh$	$I_{xx} = \frac{BH^3 + bh^3}{12}$	$\frac{H}{2}$	$Z_{xx} = \frac{BH^3 + bh^3}{6H}$	$k_{xx} = 0.289 \sqrt{\frac{BH^3 + bh^3}{BH + bh}}$
<p>15. Cross-section</p>	$BH + bh$	$I_{xx} = \frac{Bh^3 + bh^3}{12}$	$\frac{H}{2}$	$Z_{xx} = \frac{BH^3 + bh^3}{6H}$	$k_{xx} = 0.289 \sqrt{\frac{BH^3 + bh^3}{BH + bh}}$

Example 5.6. A pump lever rocking shaft is shown in Fig. 5.5. The pump lever exerts forces of 25 kN and 35 kN concentrated at 150 mm and 200 mm from the left and right hand bearing respectively. Find the diameter of the central portion of the shaft, if the stress is not to exceed 100 MPa.

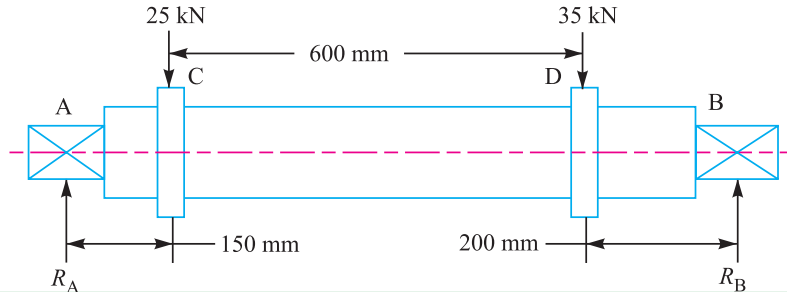

Fig. 5.5

Solution. Given : $\sigma_b = 100 \text{ MPa} = 100 \text{ N/mm}^2$

Let R_A and R_B = Reactions at A and B respectively.

Taking moments about A, we have

$$R_B \times 950 = 35 \times 750 + 25 \times 150 = 30\,000$$

$$\therefore R_B = 30\,000 / 950 = 31.58 \text{ kN} = 31.58 \times 10^3 \text{ N}$$

and $R_A = (25 + 35) - 31.58 = 28.42 \text{ kN} = 28.42 \times 10^3 \text{ N}$

\therefore Bending moment at C

$$= R_A \times 150 = 28.42 \times 10^3 \times 150 = 4.263 \times 10^6 \text{ N-mm}$$

and bending moment at D $= R_B \times 200 = 31.58 \times 10^3 \times 200 = 6.316 \times 10^6 \text{ N-mm}$

We see that the maximum bending moment is at D, therefore maximum bending moment, $M = 6.316 \times 10^6 \text{ N-mm}$.

Let d = Diameter of the shaft.

\therefore Section modulus,

$$Z = \frac{\pi}{32} \times d^3 = 0.0982 d^3$$

We know that bending stress (σ_b),

$$100 = \frac{M}{Z} = \frac{6.316 \times 10^6}{0.0982 d^3} = \frac{64.32 \times 10^6}{d^3}$$

$$\therefore d^3 = 64.32 \times 10^6 / 100 = 643.2 \times 10^3 \text{ or } d = 86.3 \text{ say } 90 \text{ mm Ans.}$$

Example 5.7. An axle 1 metre long supported in bearings at its ends carries a fly wheel weighing 30 kN at the centre. If the stress (bending) is not to exceed 60 MPa, find the diameter of the axle.

Solution. Given : $L = 1 \text{ m} = 1000 \text{ mm}$; $W = 30 \text{ kN} = 30 \times 10^3 \text{ N}$; $\sigma_b = 60 \text{ MPa} = 60 \text{ N/mm}^2$

The axle with a flywheel is shown in Fig. 5.6.

Let d = Diameter of the axle in mm.



The picture shows a method where sensors are used to measure torsion

Note : This picture is given as additional information and is not a direct example of the current chapter.

136 ■ A Textbook of Machine Design

∴ Section modulus,

$$Z = \frac{\pi}{32} \times d^3 = 0.0982 d^3$$

Maximum bending moment at the centre of the axle,

$$M = \frac{W \cdot L}{4} = \frac{30 \times 10^3 \times 1000}{4} = 7.5 \times 10^6 \text{ N-mm}$$

We know that bending stress (σ_b),

$$60 = \frac{M}{Z} = \frac{7.5 \times 10^6}{0.0982 d^3} = \frac{76.4 \times 10^6}{d^3}$$

∴ $d^3 = 76.4 \times 10^6 / 60 = 1.27 \times 10^6$ or $d = 108.3$ say 110 mm **Ans.**

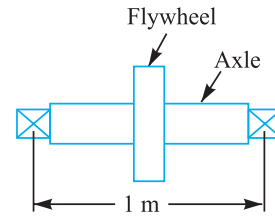

Fig. 5.6

Example 5.8. A beam of uniform rectangular cross-section is fixed at one end and carries an electric motor weighing 400 N at a distance of 300 mm from the fixed end. The maximum bending stress in the beam is 40 MPa. Find the width and depth of the beam, if depth is twice that of width.

Solution. Given: $W = 400 \text{ N}$; $L = 300 \text{ mm}$; $\sigma_b = 40 \text{ MPa} = 40 \text{ N/mm}^2$; $h = 2b$

The beam is shown in Fig. 5.7.

Let $b =$ Width of the beam in mm, and

$h =$ Depth of the beam in mm.

∴ Section modulus,

$$Z = \frac{b \cdot h^2}{6} = \frac{b (2b)^2}{6} = \frac{2 b^3}{3} \text{ mm}^3$$

Maximum bending moment (at the fixed end),

$$M = W \cdot L = 400 \times 300 = 120 \times 10^3 \text{ N-mm}$$

We know that bending stress (σ_b),

$$40 = \frac{M}{Z} = \frac{120 \times 10^3 \times 3}{2 b^3} = \frac{180 \times 10^3}{b^3}$$

∴ $b^3 = 180 \times 10^3 / 40 = 4.5 \times 10^3$ or $b = 16.5 \text{ mm}$ **Ans.**

and

$$h = 2b = 2 \times 16.5 = 33 \text{ mm}$$
 Ans.

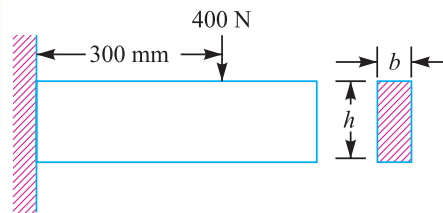

Fig. 5.7

Example 5.9. A cast iron pulley transmits 10 kW at 400 r.p.m. The diameter of the pulley is 1.2 metre and it has four straight arms of elliptical cross-section, in which the major axis is twice the minor axis. Determine the dimensions of the arm if the allowable bending stress is 15 MPa.

Solution. Given : $P = 10 \text{ kW} = 10 \times 10^3 \text{ W}$; $N = 400 \text{ r.p.m}$; $D = 1.2 \text{ m} = 1200 \text{ mm}$ or $R = 600 \text{ mm}$; $\sigma_b = 15 \text{ MPa} = 15 \text{ N/mm}^2$

Let $T =$ Torque transmitted by the pulley.

We know that the power transmitted by the pulley (P),

$$10 \times 10^3 = \frac{2 \pi N \cdot T}{60} = \frac{2 \pi \times 400 \times T}{60} = 42 T$$

∴ $T = 10 \times 10^3 / 42 = 238 \text{ N-m} = 238 \times 10^3 \text{ N-mm}$

Since the torque transmitted is the product of the tangential load and the radius of the pulley, therefore tangential load acting on the pulley

$$= \frac{T}{R} = \frac{238 \times 10^3}{600} = 396.7 \text{ N}$$

Since the pulley has four arms, therefore tangential load on each arm,

$$W = 396.7/4 = 99.2 \text{ N}$$

and maximum bending moment on the arm,

$$M = W \times R = 99.2 \times 600 = 59\,520 \text{ N-mm}$$

Let $2b$ = Minor axis in mm, and

$$2a = \text{Major axis in mm} = 2 \times 2b = 4b \quad \dots(\text{Given})$$

∴ Section modulus for an elliptical cross-section,

$$Z = \frac{\pi}{4} \times a^2 b = \frac{\pi}{4} (2b)^2 \times b = \pi b^3 \text{ mm}^3$$

We know that bending stress (σ_b),

$$15 = \frac{M}{Z} = \frac{59\,520}{\pi b^3} = \frac{18\,943}{b^3}$$

or $b^3 = 18\,943/15 = 1263$ or $b = 10.8 \text{ mm}$

∴ Minor axis, $2b = 2 \times 10.8 = 21.6 \text{ mm Ans.}$

and major axis, $2a = 2 \times 2b = 4 \times 10.8 = 43.2 \text{ mm Ans.}$

5.5 Bending Stress in Curved Beams

We have seen in the previous article that for the straight beams, the neutral axis of the section coincides with its centroidal axis and the stress distribution in the beam is linear. But in case of curved beams, the neutral axis of the cross-section is shifted towards the centre of curvature of the beam causing a non-linear (hyperbolic) distribution of stress, as shown in Fig. 5.8. It may be noted that the neutral axis lies between the centroidal axis and the centre of curvature and always occurs within the curved beams. The application of curved beam principle is used in crane hooks, chain links and frames of punches, presses, planers etc.

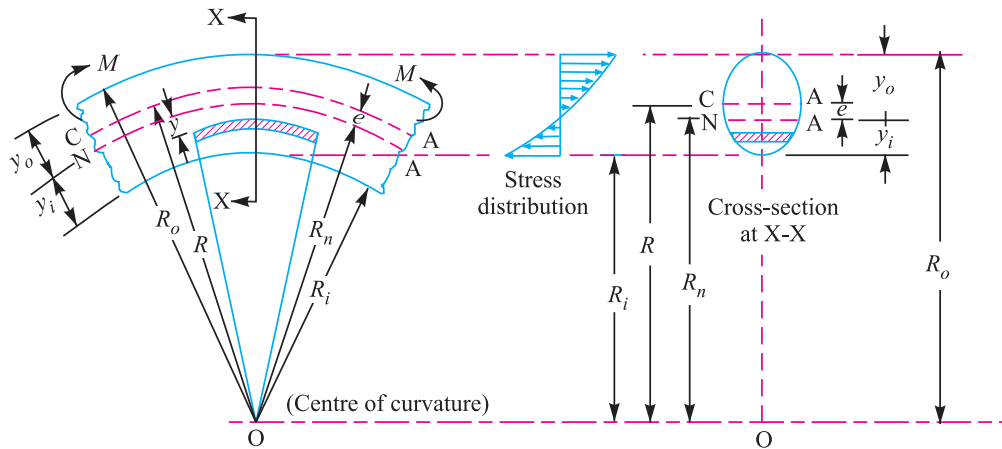

Fig. 5.8. Bending stress in a curved beam.

Consider a curved beam subjected to a bending moment M , as shown in Fig. 5.8. In finding the bending stress in curved beams, the same assumptions are used as for straight beams. The general expression for the bending stress (σ_b) in a curved beam at any fibre at a distance y from the neutral

axis, is given by

$$\sigma_b = \frac{M}{A \cdot e} \left(\frac{y}{R_n - y} \right)$$

where

M = Bending moment acting at the given section about the centroidal axis,

A = Area of cross-section,

e = Distance from the centroidal axis to the neutral axis = $R - R_n$,

R = Radius of curvature of the centroidal axis,

R_n = Radius of curvature of the neutral axis, and

y = Distance from the neutral axis to the fibre under consideration. It is positive for the distances towards the centre of curvature and negative for the distances away from the centre of curvature.

Notes : 1. The bending stress in the curved beam is zero at a point other than at the centroidal axis.

2. If the section is symmetrical such as a circle, rectangle, I-beam with equal flanges, then the maximum bending stress will always occur at the inside fibre.

3. If the section is unsymmetrical, then the maximum bending stress may occur at either the inside fibre or the outside fibre. The maximum bending stress at the inside fibre is given by

$$\sigma_{bi} = \frac{M \cdot y_i}{A \cdot e \cdot R_i}$$

where

y_i = Distance from the neutral axis to the inside fibre = $R_n - R_i$, and

R_i = Radius of curvature of the inside fibre.

The maximum bending stress at the outside fibre is given by

$$\sigma_{bo} = \frac{M \cdot y_o}{A \cdot e \cdot R_o}$$

where

y_o = Distance from the neutral axis to the outside fibre = $R_o - R_n$, and

R_o = Radius of curvature of the outside fibre.

It may be noted that the bending stress at the inside fibre is *tensile* while the bending stress at the outside fibre is *compressive*.

4. If the section has an axial load in addition to bending, then the axial or direct stress (σ_d) must be added algebraically to the bending stress, in order to obtain the resultant stress on the section. In other words,

Resultant stress, $\sigma = \sigma_d \pm \sigma_b$

The following table shows the values of R_n and R for various commonly used cross-sections in curved beams.

Table 5.2. Values of R_n and R for various commonly used cross-section in curved beams.

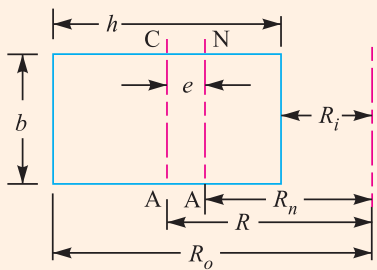
Section	Values of R_n and R
	$R_n = \frac{h}{\log_e \left(\frac{R_o}{R_i} \right)}$ $R = R_i + \frac{h}{2}$

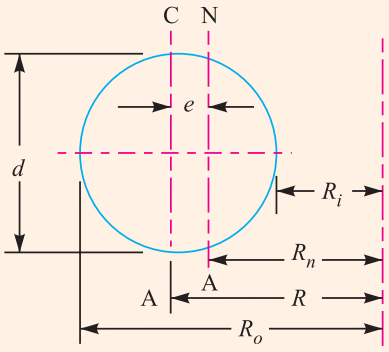
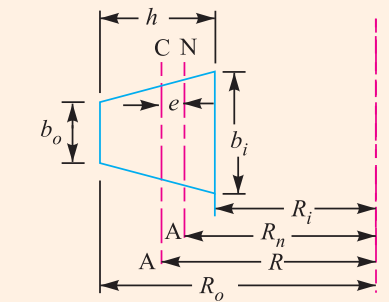
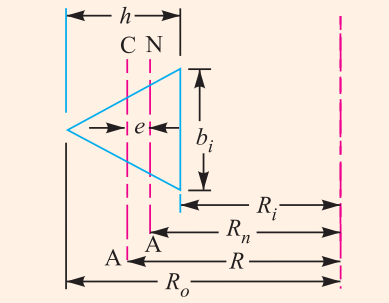
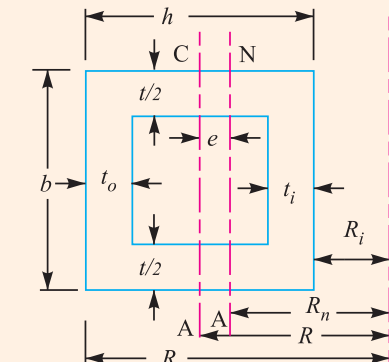
Section	Values of R_n and R
	$R_n = \frac{[\sqrt{R_o} + \sqrt{R_i}]^2}{4}$ $R = R_i + \frac{d}{2}$
	$R_n = \frac{\left(\frac{b_i + b_o}{2}\right) h}{\left(\frac{b_i R_o - b_o R_i}{h}\right) \log_e \left(\frac{R_o}{R_i}\right) - (b_i - b_o)}$ $R = R_i + \frac{h(b_i + 2b_o)}{3(b_i + b_o)}$
	$R_n = \frac{\frac{1}{2} b_i \times h}{\frac{b_i R_o}{h} \log_e \left(\frac{R_o}{R_i}\right) - b_i}$ $R = R_i + \frac{h}{3}$
	$R_n = \frac{(b-t)(t_i + t_o) + t \cdot h}{b \left[\log_e \left(\frac{R_i + t_i}{R_i}\right) + \log_e \left(\frac{R_o}{R_o - t_o}\right) \right] + t \cdot \log_e \left(\frac{R_o - t_o}{R_i + t_i}\right)}$ $R = R_i + \frac{\frac{1}{2} h^2 \cdot t + \frac{1}{2} t_i^2 (b-t) + (b-t) t_o \left(h - \frac{1}{2} t_o\right)}{h t + (b-t)(t_i + t_o)}$

Section	Values of R_n and R
	$R_n = \frac{t_i(b_i - t) + t.h}{(b_i - t) \log_e \left(\frac{R_i + t_i}{R_i} \right) + t \log_e \left(\frac{R_o}{R_i} \right)}$ $R = R_i + \frac{\frac{1}{2} h^2 t + \frac{1}{2} t_i^2 (b_i - t)}{h.t + t_i (b_i - t)}$
	$R_n = \frac{t_i(b_i - t) + t_o(b_o - t) + t.h}{b_i \log_e \left(\frac{R_i + t_i}{R_i} \right) + t \log_e \left(\frac{R_o - t_o}{R_i + t_i} \right) + b_o \log_e \left(\frac{R_o}{R_o - t_o} \right)}$ $R = R_i + \frac{\frac{1}{2} h^2 t + \frac{1}{2} t_i^2 (b_i - t) + (b_o - t) t_o (h - \frac{1}{2} t_o)}{t_i (b_i - t) + t_o (b_o - t) + t.h}$

Example 5.10. The frame of a punch press is shown in Fig. 5.9. Find the stresses at the inner and outer surface at section X-X of the frame, if $W = 5000$ N.

Solution. Given : $W = 5000$ N ; $b_i = 18$ mm ; $b_o = 6$ mm ; $h = 40$ mm ; $R_i = 25$ mm ; $R_o = 25 + 40 = 65$ mm

We know that area of section at X-X,

$$A = \frac{1}{2} (18 + 6) 40 = 480 \text{ mm}^2$$

The various distances are shown in Fig. 5.10.

We know that radius of curvature of the neutral axis,

$$R_n = \frac{\left(\frac{b_i + b_o}{2} \right) h}{\left(\frac{b_i R_o - b_o R_i}{h} \right) \log_e \left(\frac{R_o}{R_i} \right) - (b_i - b_o)}$$

$$= \frac{\left(\frac{18 + 6}{2} \right) \times 40}{\left(\frac{18 \times 65 - 6 \times 25}{40} \right) \log_e \left(\frac{65}{25} \right) - (18 - 6)}$$

$$= \frac{480}{(25.5 \times 0.9555) - 12} = 38.83 \text{ mm}$$

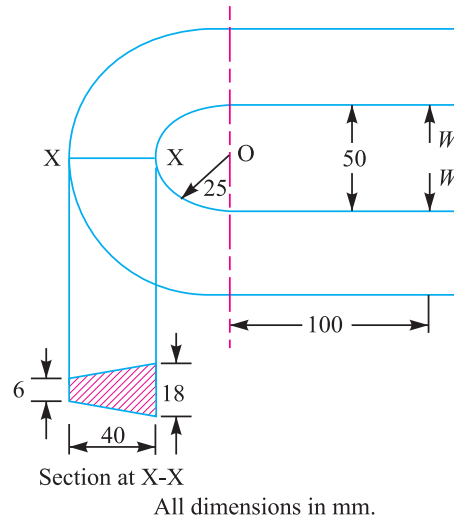

Fig. 5.9

and radius of curvature of the centroidal axis,

$$R = R_i + \frac{h(b_i + 2b_o)}{3(b_i + b_o)} = 25 + \frac{40(18 + 2 \times 6)}{3(18 + 6)} \text{ mm}$$

$$= 25 + 16.67 = 41.67 \text{ mm}$$

Distance between the centroidal axis and neutral axis,

$$e = R - R_n = 41.67 - 38.83 = 2.84 \text{ mm}$$

and the distance between the load and centroidal axis,

$$x = 100 + R = 100 + 41.67 = 141.67 \text{ mm}$$

∴ Bending moment about the centroidal axis,

$$M = W \cdot x = 5000 \times 141.67 = 708\,350 \text{ N-mm}$$

The section at X-X is subjected to a direct tensile load of $W = 5000 \text{ N}$ and a bending moment of $M = 708\,350 \text{ N-mm}$. We know that direct tensile stress at section X-X,

$$\sigma_t = \frac{W}{A} = \frac{5000}{480} = 10.42 \text{ N/mm}^2 = 10.42 \text{ MPa}$$

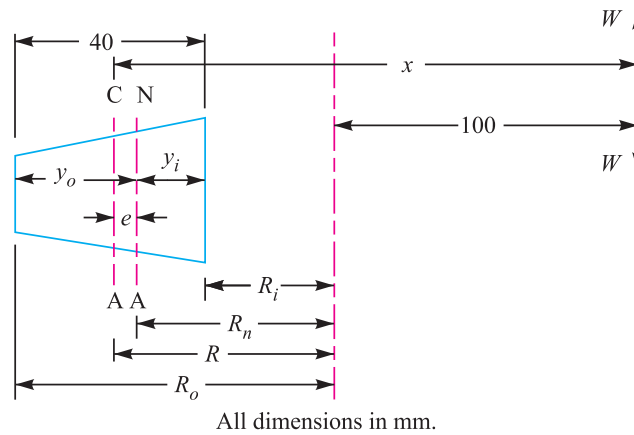

Fig. 5.10

Distance from the neutral axis to the inner surface,

$$y_i = R_n - R_i = 38.83 - 25 = 13.83 \text{ mm}$$

Distance from the neutral axis to the outer surface,

$$y_o = R_o - R_n = 65 - 38.83 = 26.17 \text{ mm}$$

We know that maximum bending stress at the inner surface,

$$\sigma_{bi} = \frac{M \cdot y_i}{A \cdot e \cdot R_i} = \frac{708\,350 \times 13.83}{480 \times 2.84 \times 25} = 287.4 \text{ N/mm}^2$$

$$= 287.4 \text{ MPa (tensile)}$$

and maximum bending stress at the outer surface,

$$\sigma_{bo} = \frac{M \cdot y_o}{A \cdot e \cdot R_o} = \frac{708\,350 \times 26.17}{480 \times 2.84 \times 65} = 209.2 \text{ N/mm}^2$$

$$= 209.2 \text{ MPa (compressive)}$$

142 ■ A Textbook of Machine Design

∴ Resultant stress on the inner surface

$$= \sigma_t + \sigma_{bi} = 10.42 + 287.4 = 297.82 \text{ MPa (tensile) Ans.}$$

and resultant stress on the outer surface,

$$= \sigma_t - \sigma_{bo} = 10.42 - 209.2 = -198.78 \text{ MPa}$$

$$= 198.78 \text{ MPa (compressive) Ans.}$$



A big crane hook

Example 5.11. The crane hook carries a load of 20 kN as shown in Fig. 5.11. The section at X-X is rectangular whose horizontal side is 100 mm. Find the stresses in the inner and outer fibres at the given section.

Solution. Given : $W = 20 \text{ kN} = 20 \times 10^3 \text{ N}$; $R_i = 50 \text{ mm}$; $R_o = 150 \text{ mm}$; $h = 100 \text{ mm}$; $b = 20 \text{ mm}$
We know that area of section at X-X,

$$A = b.h = 20 \times 100 = 2000 \text{ mm}^2$$

The various distances are shown in Fig. 5.12.

We know that radius of curvature of the neutral axis,

$$R_n = \frac{h}{\log_e \left(\frac{R_o}{R_i} \right)} = \frac{100}{\log_e \left(\frac{150}{50} \right)} = \frac{100}{1.098} = 91.07 \text{ mm}$$

and radius of curvature of the centroidal axis,

$$R = R_i + \frac{h}{2} = 50 + \frac{100}{2} = 100 \text{ mm}$$

∴ Distance between the centroidal axis and neutral axis,

$$e = R - R_n = 100 - 91.07 = 8.93 \text{ mm}$$

and distance between the load and the centroidal axis,

$$x = R = 100 \text{ mm}$$

∴ Bending moment about the centroidal axis,

$$M = W \times x = 20 \times 10^3 \times 100 = 2 \times 10^6 \text{ N-mm}$$

The section at X-X is subjected to a direct tensile load of $W = 20 \times 10^3$ N and a bending moment of $M = 2 \times 10^6$ N-mm. We know that direct tensile stress at section X-X,

$$\sigma_t = \frac{W}{A} = \frac{20 \times 10^3}{2000} = 10 \text{ N/mm}^2 = 10 \text{ MPa}$$

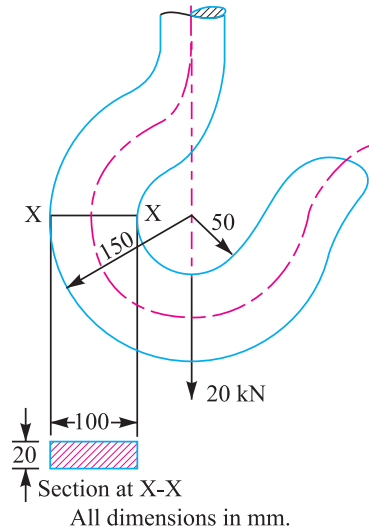

Fig. 5.11

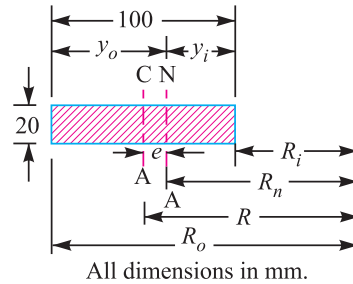

Fig. 5.12

We know that the distance from the neutral axis to the inside fibre,

$$y_i = R_n - R_i = 91.07 - 50 = 41.07 \text{ mm}$$

and distance from the neutral axis to outside fibre,

$$y_o = R_o - R_n = 150 - 91.07 = 58.93 \text{ mm}$$

∴ Maximum bending stress at the inside fibre,

$$\sigma_{bi} = \frac{M \cdot y_i}{A \cdot e \cdot R_i} = \frac{2 \times 10^6 \times 41.07}{2000 \times 8.93 \times 50} = 92 \text{ N/mm}^2 = 92 \text{ MPa (tensile)}$$

and maximum bending stress at the outside fibre,

$$\begin{aligned} \sigma_{bo} &= \frac{M \cdot y_o}{A \cdot e \cdot R_o} = \frac{2 \times 10^6 \times 58.93}{2000 \times 8.93 \times 150} = 44 \text{ N/mm}^2 \\ &= 44 \text{ MPa (compressive)} \end{aligned}$$

∴ Resultant stress at the inside fibre

$$= \sigma_t + \sigma_{bi} = 10 + 92 = 102 \text{ MPa (tensile) Ans.}$$

and resultant stress at the outside fibre

$$= \sigma_t - \sigma_{bo} = 10 - 44 = -34 \text{ MPa} = 34 \text{ MPa (compressive) Ans.}$$

Example 5.12. A C-clamp is subjected to a maximum load of W , as shown in Fig. 5.13. If the maximum tensile stress in the clamp is limited to 140 MPa, find the value of load W .

Solution. Given : $\sigma_{t(max)} = 140 \text{ MPa} = 140 \text{ N/mm}^2$; $R_i = 25 \text{ mm}$; $R_o = 25 + 25 = 50 \text{ mm}$; $b_i = 19 \text{ mm}$; $t_i = 3 \text{ mm}$; $t = 3 \text{ mm}$; $h = 25 \text{ mm}$

We know that area of section at X-X,

$$A = 3 \times 22 + 3 \times 19 = 123 \text{ mm}^2$$

144 ■ A Textbook of Machine Design

The various distances are shown in Fig. 5.14. We know that radius of curvature of the neutral axis,

$$R_n = \frac{t_i (b_i - t) + t \cdot h}{(b_i - t) \log_e \left(\frac{R_i + t_i}{R_i} \right) + t \log_e \left(\frac{R_o}{R_i} \right)}$$

$$= \frac{3 (19 - 3) + 3 \times 25}{(19 - 3) \log_e \left(\frac{25 + 3}{25} \right) + 3 \log_e \left(\frac{50}{25} \right)}$$

$$= \frac{123}{16 \times 0.113 + 3 \times 0.693} = \frac{123}{3.887} = 31.64 \text{ mm}$$

and radius of curvature of the centroidal axis,

$$R = R_i + \frac{\frac{1}{2} h^2 \cdot t + \frac{1}{2} t_i^2 (b_i - t)}{h \cdot t + t_i (b_i - t)}$$

$$= 25 + \frac{\frac{1}{2} \times 25^2 \times 3 + \frac{1}{2} \times 3^2 (19 - 3)}{25 \times 3 + 3 (19 - 3)} = 25 + \frac{937.5 + 72}{75 + 48}$$

$$= 25 + 8.2 = 33.2 \text{ mm}$$

Distance between the centroidal axis and neutral axis,

$$e = R - R_n = 33.2 - 31.64 = 1.56 \text{ mm}$$

and distance between the load W and the centroidal axis,

$$x = 50 + R = 50 + 33.2 = 83.2 \text{ mm}$$

∴ Bending moment about the centroidal axis,

$$M = W \cdot x = W \times 83.2 = 83.2 \text{ W N-m}$$

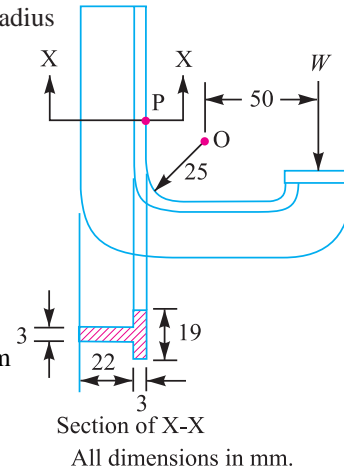

Fig. 5.13

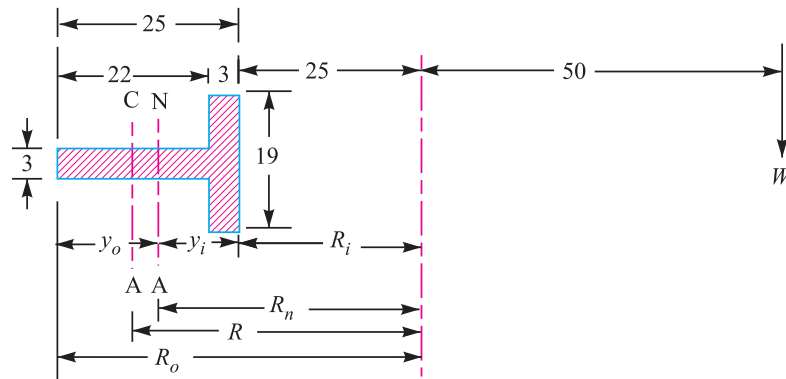

Fig. 5.14

The section at X-X is subjected to a direct tensile load of W and a bending moment of $83.2 W$. The maximum tensile stress will occur at point P (i.e. at the inner fibre of the section).

Distance from the neutral axis to the point P ,

$$y_i = R_n - R_i = 31.64 - 25 = 6.64 \text{ mm}$$

Direct tensile stress at section X-X,

$$\sigma_t = \frac{W}{A} = \frac{W}{123} = 0.008 W \text{ N/mm}^2$$

and maximum bending stress at point P,

$$\sigma_{bi} = \frac{M \cdot y_i}{A \cdot e \cdot R_i} = \frac{83.2 W \times 6.64}{123 \times 1.56 \times 25} = 0.115 W \text{ N/mm}^2$$

We know that the maximum tensile stress $\sigma_{t(max)}$,

$$140 = \sigma_t + \sigma_{bi} = 0.008 W + 0.115 W = 0.123 W$$

$$\therefore W = 140/0.123 = 1138 \text{ N Ans.}$$

Note : We know that distance from the neutral axis to the outer fibre,

$$y_o = R_o - R_n = 50 - 31.64 = 18.36 \text{ mm}$$

\therefore Maximum bending stress at the outer fibre,

$$\sigma_{bo} = \frac{M \cdot y_o}{A \cdot e \cdot R_o} = \frac{83.2 W \times 18.36}{123 \times 1.56 \times 50} = 0.16 W$$

and maximum stress at the outer fibre,

$$\begin{aligned} &= \sigma_t - \sigma_{bo} = 0.008 W - 0.16 W = -0.152 W \text{ N/mm}^2 \\ &= 0.152 W \text{ N/mm}^2 \text{ (compressive)} \end{aligned}$$

From above we see that stress at the outer fibre is larger in this case than at the inner fibre, but this stress at outer fibre is compressive.

5.6 Principal Stresses and Principal Planes

In the previous chapter, we have discussed about the direct tensile and compressive stress as well as simple shear. Also we have always referred the stress in a plane which is at right angles to the line of action of the force.

But it has been observed that at any point in a strained material, there are three planes, mutually perpendicular to each other which carry direct stresses only and no shear stress. It may be noted that out of these three direct stresses, one will be maximum and the other will be minimum. These perpendicular planes which have no shear stress are known as **principal planes** and the direct stresses along these planes are known as **principal stresses**. The planes on which the maximum shear stress act are known as planes of maximum shear.

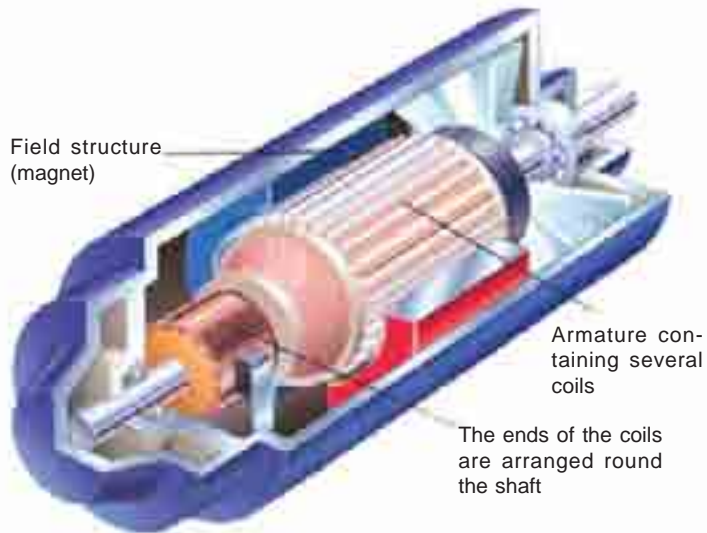

Big electric generators undergo high torsional stresses.

5.7 Determination of Principal Stresses for a Member Subjected to Bi-axial Stress

When a member is subjected to bi-axial stress (*i.e.* direct stress in two mutually perpendicular planes accompanied by a simple shear stress), then the normal and shear stresses are obtained as discussed below:

Consider a rectangular body *ABCD* of uniform cross-sectional area and unit thickness subjected to normal stresses σ_1 and σ_2 as shown in Fig. 5.15 (a). In addition to these normal stresses, a shear stress τ also acts.

It has been shown in books on ‘*Strength of Materials*’ that the normal stress across any oblique section such as *EF* inclined at an angle θ with the direction of σ_2 , as shown in Fig. 5.15 (a), is given by

$$\sigma_t = \frac{\sigma_1 + \sigma_2}{2} + \frac{\sigma_1 - \sigma_2}{2} \cos 2\theta + \tau \sin 2\theta \quad \dots(i)$$

and tangential stress (*i.e.* shear stress) across the section *EF*,

$$\tau_1 = \frac{1}{2} (\sigma_1 - \sigma_2) \sin 2\theta - \tau \cos 2\theta \quad \dots(ii)$$

Since the planes of maximum and minimum normal stress (*i.e.* principal planes) have no shear stress, therefore the inclination of principal planes is obtained by equating $\tau_1 = 0$ in the above equation (ii), *i.e.*

$$\frac{1}{2} (\sigma_1 - \sigma_2) \sin 2\theta - \tau \cos 2\theta = 0$$

$$\therefore \tan 2\theta = \frac{2\tau}{\sigma_1 - \sigma_2} \quad \dots(iii)$$

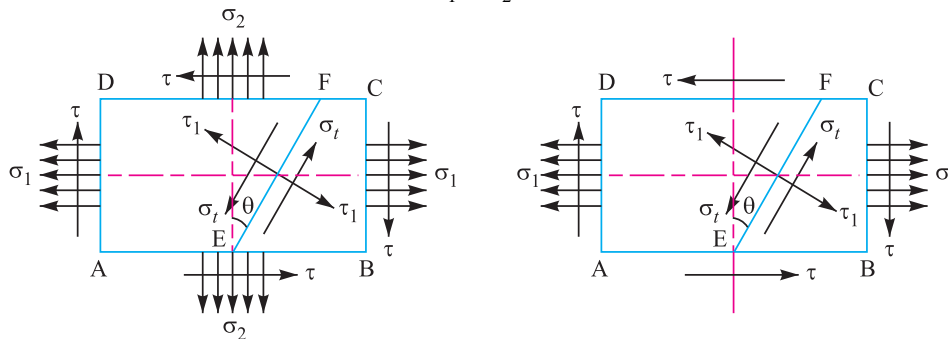

(a) Direct stress in two mutually perpendicular planes accompanied by a simple shear stress.

(b) Direct stress in one plane accompanied by a simple shear stress.

Fig. 5.15. Principal stresses for a member subjected to bi-axial stress.

We know that there are two principal planes at right angles to each other. Let θ_1 and θ_2 be the inclinations of these planes with the normal cross-section.

From Fig. 5.16, we find that

$$\sin 2\theta = \pm \frac{2\tau}{\sqrt{(\sigma_1 - \sigma_2)^2 + 4\tau^2}}$$

$$\begin{aligned} \therefore \sin 2\theta_1 &= + \frac{2\tau}{\sqrt{(\sigma_1 - \sigma_2)^2 + 4\tau^2}} \\ \text{and} \quad \sin 2\theta_2 &= - \frac{2\tau}{\sqrt{(\sigma_1 - \sigma_2)^2 + 4\tau^2}} \\ \text{Also} \quad \cos 2\theta &= \pm \frac{\sigma_1 - \sigma_2}{\sqrt{(\sigma_1 - \sigma_2)^2 + 4\tau^2}} \\ \therefore \cos 2\theta_1 &= + \frac{\sigma_1 - \sigma_2}{\sqrt{(\sigma_1 - \sigma_2)^2 + 4\tau^2}} \\ \text{and} \quad \cos 2\theta_2 &= - \frac{\sigma_1 - \sigma_2}{\sqrt{(\sigma_1 - \sigma_2)^2 + 4\tau^2}} \end{aligned}$$

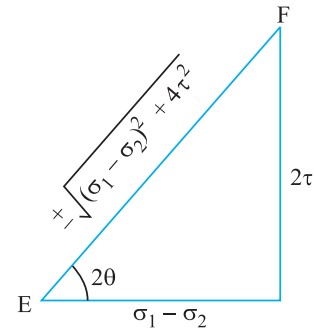

Fig. 5.16

The maximum and minimum principal stresses may now be obtained by substituting the values of $\sin 2\theta$ and $\cos 2\theta$ in equation (i).

∴ Maximum principal (or normal) stress,

$$\sigma_{t1} = \frac{\sigma_1 + \sigma_2}{2} + \frac{1}{2} \sqrt{(\sigma_1 - \sigma_2)^2 + 4\tau^2} \quad \dots(iv)$$

and minimum principal (or normal) stress,

$$\sigma_{t2} = \frac{\sigma_1 + \sigma_2}{2} - \frac{1}{2} \sqrt{(\sigma_1 - \sigma_2)^2 + 4\tau^2} \quad \dots(v)$$

The planes of maximum shear stress are at right angles to each other and are inclined at 45° to the principal planes. The maximum shear stress is given by *one-half the algebraic difference between the principal stresses, i.e.*

$$\tau_{max} = \frac{\sigma_{t1} - \sigma_{t2}}{2} = \frac{1}{2} \sqrt{(\sigma_1 - \sigma_2)^2 + 4\tau^2} \quad \dots(vi)$$



A Boring mill.

Note : This picture is given as additional information and is not a direct example of the current chapter.

Notes: 1. When a member is subjected to direct stress in one plane accompanied by a simple shear stress as shown in Fig. 5.15 (b), then the principal stresses are obtained by substituting $\sigma_2 = 0$ in equation (iv), (v) and (vi).

$$\therefore \sigma_{r1} = \frac{\sigma_1}{2} + \frac{1}{2} \left[\sqrt{(\sigma_1)^2 + 4 \tau^2} \right]$$

$$\sigma_{r2} = \frac{\sigma_1}{2} - \frac{1}{2} \left[\sqrt{(\sigma_1)^2 + 4 \tau^2} \right]$$

and

$$\tau_{max} = \frac{1}{2} \left[\sqrt{(\sigma_1)^2 + 4 \tau^2} \right]$$

2. In the above expression of σ_{r2} , the value of $\frac{1}{2} \left[\sqrt{(\sigma_1)^2 + 4 \tau^2} \right]$ is more than $\frac{\sigma_1}{2}$. Therefore the nature of σ_{r2} will be opposite to that of σ_{r1} , i.e. if σ_{r1} is tensile then σ_{r2} will be compressive and vice-versa.

5.8 Application of Principal Stresses in Designing Machine Members

There are many cases in practice, in which machine members are subjected to combined stresses due to simultaneous action of either tensile or compressive stresses combined with shear stresses. In many shafts such as propeller shafts, C-frames etc., there are direct tensile or compressive stresses due to the external force and shear stress due to torsion, which acts normal to direct tensile or compressive stresses. The shafts like crank shafts, are subjected simultaneously to torsion and bending. In such cases, the maximum principal stresses, due to the combination of tensile or compressive stresses with shear stresses may be obtained.

The results obtained in the previous article may be written as follows:

1. Maximum tensile stress,

$$\sigma_{t(max)} = \frac{\sigma_t}{2} + \frac{1}{2} \left[\sqrt{(\sigma_t)^2 + 4 \tau^2} \right]$$

2. Maximum compressive stress,

$$\sigma_{c(max)} = \frac{\sigma_c}{2} + \frac{1}{2} \left[\sqrt{(\sigma_c)^2 + 4 \tau^2} \right]$$

3. Maximum shear stress,

$$\tau_{max} = \frac{1}{2} \left[\sqrt{(\sigma_t)^2 + 4 \tau^2} \right]$$

where

σ_t = Tensile stress due to direct load and bending,

σ_c = Compressive stress, and

τ = Shear stress due to torsion.

Notes : 1. When $\tau = 0$ as in the case of thin cylindrical shell subjected in internal fluid pressure, then

$$\sigma_{t(max)} = \sigma_t$$

2. When the shaft is subjected to an axial load (P) in addition to bending and twisting moments as in the propeller shafts of ship and shafts for driving worm gears, then the stress due to axial load must be added to the bending stress (σ_b). This will give the resultant tensile stress or compressive stress (σ_t or σ_c) depending upon the type of axial load (i.e. pull or push).

Example 5.13. A hollow shaft of 40 mm outer diameter and 25 mm inner diameter is subjected to a twisting moment of 120 N-m, simultaneously, it is subjected to an axial thrust of 10 kN and a bending moment of 80 N-m. Calculate the maximum compressive and shear stresses.

Solution. Given: $d_o = 40$ mm ; $d_i = 25$ mm ; $T = 120$ N-m = 120×10^3 N-mm ; $P = 10$ kN = 10×10^3 N ; $M = 80$ N-m = 80×10^3 N-mm

We know that cross-sectional area of the shaft,

$$A = \frac{\pi}{4} [(d_o)^2 - (d_i)^2] = \frac{\pi}{4} [(40)^2 - (25)^2] = 766 \text{ mm}^2$$

∴ Direct compressive stress due to axial thrust,

$$\sigma_o = \frac{P}{A} = \frac{10 \times 10^3}{766} = 13.05 \text{ N/mm}^2 = 13.05 \text{ MPa}$$

Section modulus of the shaft,

$$Z = \frac{\pi}{32} \left[\frac{(d_o)^4 - (d_i)^4}{d_o} \right] = \frac{\pi}{32} \left[\frac{(40)^4 - (25)^4}{40} \right] = 5325 \text{ mm}^3$$

∴ Bending stress due to bending moment,

$$\sigma_b = \frac{M}{Z} = \frac{80 \times 10^3}{5325} = 15.02 \text{ N/mm}^2 = 15.02 \text{ MPa (compressive)}$$

and resultant compressive stress,

$$\sigma_c = \sigma_b + \sigma_o = 15.02 + 13.05 = 28.07 \text{ N/mm}^2 = 28.07 \text{ MPa}$$

We know that twisting moment (T),

$$120 \times 10^3 = \frac{\pi}{16} \times \tau \left[\frac{(d_o)^4 - (d_i)^4}{d_o} \right] = \frac{\pi}{16} \times \tau \left[\frac{(40)^4 - (25)^4}{40} \right] = 10\,650 \tau$$

$$\therefore \tau = 120 \times 10^3 / 10\,650 = 11.27 \text{ N/mm}^2 = 11.27 \text{ MPa}$$

Maximum compressive stress

We know that maximum compressive stress,

$$\begin{aligned} \sigma_{c(max)} &= \frac{\sigma_c}{2} + \frac{1}{2} \left[\sqrt{(\sigma_c)^2 + 4\tau^2} \right] \\ &= \frac{28.07}{2} + \frac{1}{2} \left[\sqrt{(28.07)^2 + 4(11.27)^2} \right] \\ &= 14.035 + 18 = 32.035 \text{ MPa Ans.} \end{aligned}$$

Maximum shear stress

We know that maximum shear stress,

$$\tau_{max} = \frac{1}{2} \left[\sqrt{(\sigma_c)^2 + 4\tau^2} \right] = \frac{1}{2} \left[\sqrt{(28.07)^2 + 4(11.27)^2} \right] = 18 \text{ MPa Ans.}$$

Example 5.14. A shaft, as shown in Fig. 5.17, is subjected to a bending load of 3 kN, pure torque of 1000 N-m and an axial pulling force of 15 kN.

Calculate the stresses at A and B.

Solution. Given : $W = 3 \text{ kN} = 3000 \text{ N}$;
 $T = 1000 \text{ N-m} = 1 \times 10^6 \text{ N-mm}$; $P = 15 \text{ kN}$
 $= 15 \times 10^3 \text{ N}$; $d = 50 \text{ mm}$; $x = 250 \text{ mm}$

We know that cross-sectional area of the shaft,

$$\begin{aligned} A &= \frac{\pi}{4} \times d^2 \\ &= \frac{\pi}{4} (50)^2 = 1964 \text{ mm}^2 \end{aligned}$$

∴ Tensile stress due to axial pulling at points A and B,

$$\sigma_o = \frac{P}{A} = \frac{15 \times 10^3}{1964} = 7.64 \text{ N/mm}^2 = 7.64 \text{ MPa}$$

Bending moment at points A and B,

$$M = W.x = 3000 \times 250 = 750 \times 10^3 \text{ N-mm}$$

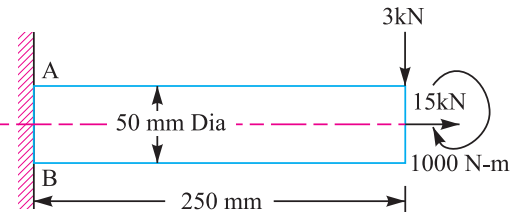

Fig. 5.17

150 ■ A Textbook of Machine Design

Section modulus for the shaft,

$$Z = \frac{\pi}{32} \times d^3 = \frac{\pi}{32} (50)^3$$

$$= 12.27 \times 10^3 \text{ mm}^3$$

∴ Bending stress at points A and B,

$$\sigma_b = \frac{M}{Z} = \frac{750 \times 10^3}{12.27 \times 10^3}$$

$$= 61.1 \text{ N/mm}^2 = 61.1 \text{ MPa}$$

This bending stress is tensile at point A and compressive at point B.

∴ Resultant tensile stress at point A,

$$\sigma_A = \sigma_b + \sigma_o = 61.1 + 7.64$$

$$= 68.74 \text{ MPa}$$

and resultant compressive stress at point B,

$$\sigma_B = \sigma_b - \sigma_o = 61.1 - 7.64 = 53.46 \text{ MPa}$$

We know that the shear stress at points A and B due to the torque transmitted,

$$\tau = \frac{16 T}{\pi d^3} = \frac{16 \times 1 \times 10^6}{\pi (50)^3} = 40.74 \text{ N/mm}^2 = 40.74 \text{ MPa} \quad \dots \left(\because T = \frac{\pi}{16} \times \tau \times d^3 \right)$$

Stresses at point A

We know that maximum principal (or normal) stress at point A,

$$\sigma_{A(max)} = \frac{\sigma_A}{2} + \frac{1}{2} \left[\sqrt{(\sigma_A)^2 + 4 \tau^2} \right]$$

$$= \frac{68.74}{2} + \frac{1}{2} \left[\sqrt{(68.74)^2 + 4 (40.74)^2} \right]$$

$$= 34.37 + 53.3 = 87.67 \text{ MPa (tensile) Ans.}$$

Minimum principal (or normal) stress at point A,

$$\sigma_{A(min)} = \frac{\sigma_A}{2} - \frac{1}{2} \left[\sqrt{(\sigma_A)^2 + 4 \tau^2} \right] = 34.37 - 53.3 = -18.93 \text{ MPa}$$

$$= 18.93 \text{ MPa (compressive) Ans.}$$

and maximum shear stress at point A,

$$\tau_{A(max)} = \frac{1}{2} \left[\sqrt{(\sigma_A)^2 + 4 \tau^2} \right] = \frac{1}{2} \left[\sqrt{(68.74)^2 + 4 (40.74)^2} \right]$$

$$= 53.3 \text{ MPa Ans.}$$

Stresses at point B

We know that maximum principal (or normal) stress at point B,

$$\sigma_{B(max)} = \frac{\sigma_B}{2} + \frac{1}{2} \left[\sqrt{(\sigma_B)^2 + 4 \tau^2} \right]$$

$$= \frac{53.46}{2} + \frac{1}{2} \left[\sqrt{(53.46)^2 + 4 (40.74)^2} \right]$$

$$= 26.73 + 48.73 = 75.46 \text{ MPa (compressive) Ans.}$$



This picture shows a machine component inside a crane

Note : This picture is given as additional information and is not a direct example of the current chapter.

Minimum principal (or normal) stress at point *B*,

$$\begin{aligned}\sigma_{B(min)} &= \frac{\sigma_B}{2} - \frac{1}{2} \left[\sqrt{(\sigma_B)^2 + 4\tau^2} \right] \\ &= 26.73 - 48.73 = -22 \text{ MPa} \\ &= 22 \text{ MPa (tensile) Ans.}\end{aligned}$$

and maximum shear stress at point *B*,

$$\begin{aligned}\tau_{B(max)} &= \frac{1}{2} \left[\sqrt{(\sigma_B)^2 + 4\tau^2} \right] = \frac{1}{2} \left[\sqrt{(53.46)^2 + 4(40.74)^2} \right] \\ &= 48.73 \text{ MPa Ans.}\end{aligned}$$

Example 5.15. An overhang crank with pin and shaft is shown in Fig. 5.18. A tangential load of 15 kN acts on the crank pin. Determine the maximum principal stress and the maximum shear stress at the centre of the crankshaft bearing.

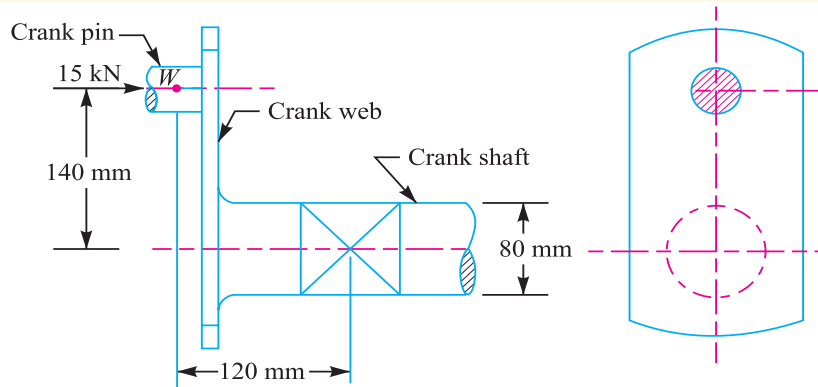

Fig. 5.18

Solution. Given : $W = 15 \text{ kN} = 15 \times 10^3 \text{ N}$; $d = 80 \text{ mm}$; $y = 140 \text{ mm}$; $x = 120 \text{ mm}$

Bending moment at the centre of the crankshaft bearing,

$$M = W \times x = 15 \times 10^3 \times 120 = 1.8 \times 10^6 \text{ N-mm}$$

and torque transmitted at the axis of the shaft,

$$T = W \times y = 15 \times 10^3 \times 140 = 2.1 \times 10^6 \text{ N-mm}$$

We know that bending stress due to the bending moment,

$$\begin{aligned}\sigma_b &= \frac{M}{Z} = \frac{32 M}{\pi d^3} \quad \dots \left(\because Z = \frac{\pi}{32} \times d^3 \right) \\ &= \frac{32 \times 1.8 \times 10^6}{\pi (80)^3} = 35.8 \text{ N/mm}^2 = 35.8 \text{ MPa}\end{aligned}$$

and shear stress due to the torque transmitted,

$$\tau = \frac{16 T}{\pi d^3} = \frac{16 \times 2.1 \times 10^6}{\pi (80)^3} = 20.9 \text{ N/mm}^2 = 20.9 \text{ MPa}$$

Maximum principal stress

We know that maximum principal stress,

$$\begin{aligned}\sigma_{t(max)} &= \frac{\sigma_t}{2} + \frac{1}{2} \left[\sqrt{(\sigma_t)^2 + 4\tau^2} \right] \\ &= \frac{35.8}{2} + \frac{1}{2} \left[\sqrt{(35.8)^2 + 4(20.9)^2} \right] \quad \dots \text{(Substituting } \sigma_t = \sigma_b) \\ &= 17.9 + 27.5 = 45.4 \text{ MPa Ans.}\end{aligned}$$

Maximum shear stress

We know that maximum shear stress,

$$\begin{aligned}\tau_{max} &= \frac{1}{2} \left[\sqrt{(\sigma_t)^2 + 4 \tau^2} \right] = \frac{1}{2} \left[\sqrt{(35.8)^2 + 4 (20.9)^2} \right] \\ &= 27.5 \text{ MPa Ans.}\end{aligned}$$

5.9 Theories of Failure Under Static Load

It has already been discussed in the previous chapter that strength of machine members is based upon the mechanical properties of the materials used. Since these properties are usually determined from simple tension or compression tests, therefore, predicting failure in members subjected to uni-axial stress is both simple and straight-forward. But the problem of predicting the failure stresses for members subjected to bi-axial or tri-axial stresses is much more complicated. In fact, the problem is so complicated that a large number of different theories have been formulated. The principal theories of failure for a member subjected to bi-axial stress are as follows:

1. Maximum principal (or normal) stress theory (also known as Rankine's theory).
2. Maximum shear stress theory (also known as Guest's or Tresca's theory).
3. Maximum principal (or normal) strain theory (also known as Saint Venant theory).
4. Maximum strain energy theory (also known as Haigh's theory).
5. Maximum distortion energy theory (also known as Hencky and Von Mises theory).

Since ductile materials usually fail by yielding *i.e.* when permanent deformations occur in the material and brittle materials fail by fracture, therefore the limiting strength for these two classes of materials is normally measured by different mechanical properties. For ductile materials, the limiting strength is the stress at yield point as determined from simple tension test and it is, assumed to be equal in tension or compression. For brittle materials, the limiting strength is the ultimate stress in tension or compression.

5.10 Maximum Principal or Normal Stress Theory (Rankine's Theory)

According to this theory, the failure or yielding occurs at a point in a member when the maximum principal or normal stress in a bi-axial stress system reaches the limiting strength of the material in a simple tension test.

Since the limiting strength for ductile materials is yield point stress and for brittle materials (which do not have well defined yield point) the limiting strength is ultimate stress, therefore according

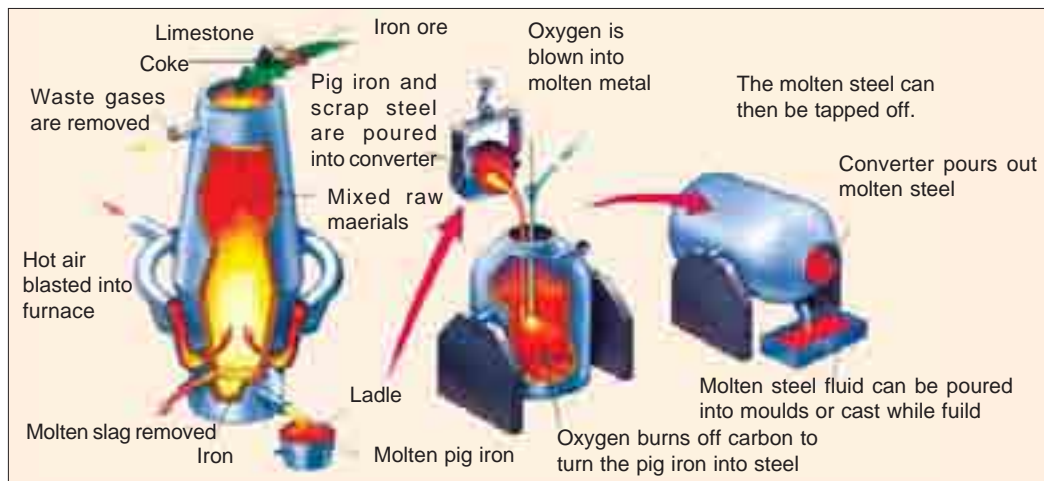

Pig iron is made from iron ore in a blast furnace. It is a brittle form of iron that contains 4-5 per cent carbon.

Note : This picture is given as additional information and is not a direct example of the current chapter.

to the above theory, taking factor of safety ($F.S.$) into consideration, the maximum principal or normal stress (σ_{t1}) in a bi-axial stress system is given by

$$\begin{aligned}\sigma_{t1} &= \frac{\sigma_{yt}}{F.S.}, \text{ for ductile materials} \\ &= \frac{\sigma_u}{F.S.}, \text{ for brittle materials}\end{aligned}$$

where

$$\begin{aligned}\sigma_{yt} &= \text{Yield point stress in tension as determined from simple tension test, and} \\ \sigma_u &= \text{Ultimate stress.}\end{aligned}$$

Since the maximum principal or normal stress theory is based on failure in tension or compression and ignores the possibility of failure due to shearing stress, therefore it is not used for ductile materials. However, for brittle materials which are relatively strong in shear but weak in tension or compression, this theory is generally used.

Note : The value of maximum principal stress (σ_{t1}) for a member subjected to bi-axial stress system may be determined as discussed in Art. 5.7.

5.11 Maximum Shear Stress Theory (Guest's or Tresca's Theory)

According to this theory, the failure or yielding occurs at a point in a member when the maximum shear stress in a bi-axial stress system reaches a value equal to the shear stress at yield point in a simple tension test. Mathematically,

$$\tau_{max} = \tau_{yt}/F.S. \quad \dots(i)$$

where

$$\begin{aligned}\tau_{max} &= \text{Maximum shear stress in a bi-axial stress system,} \\ \tau_{yt} &= \text{Shear stress at yield point as determined from simple tension test, and} \\ F.S. &= \text{Factor of safety.}\end{aligned}$$

Since the shear stress at yield point in a simple tension test is equal to one-half the yield stress in tension, therefore the equation (i) may be written as

$$\tau_{max} = \frac{\sigma_{yt}}{2 \times F.S.}$$

This theory is mostly used for designing members of ductile materials.

Note: The value of maximum shear stress in a bi-axial stress system (τ_{max}) may be determined as discussed in Art. 5.7.

5.12 Maximum Principal Strain Theory (Saint Venant's Theory)

According to this theory, the failure or yielding occurs at a point in a member when the maximum principal (or normal) strain in a bi-axial stress system reaches the limiting value of strain (*i.e.* strain at yield point) as determined from a simple tensile test. The maximum principal (or normal) strain in a bi-axial stress system is given by

$$\epsilon_{max} = \frac{\sigma_{t1}}{E} - \frac{\sigma_{t2}}{m \cdot E}$$

∴ According to the above theory,

$$\epsilon_{max} = \frac{\sigma_{t1}}{E} - \frac{\sigma_{t2}}{m \cdot E} = \epsilon = \frac{\sigma_{yt}}{E \times F.S.} \quad \dots(i)$$

where

$$\begin{aligned}\sigma_{t1} \text{ and } \sigma_{t2} &= \text{Maximum and minimum principal stresses in a bi-axial stress system,} \\ \epsilon &= \text{Strain at yield point as determined from simple tension test,} \\ 1/m &= \text{Poisson's ratio,} \\ E &= \text{Young's modulus, and} \\ F.S. &= \text{Factor of safety.}\end{aligned}$$

154 ■ A Textbook of Machine Design

From equation (i), we may write that

$$\sigma_{t1} - \frac{\sigma_{t2}}{m} = \frac{\sigma_{yt}}{F.S.}$$

This theory is not used, in general, because it only gives reliable results in particular cases.

5.13 Maximum Strain Energy Theory (Haigh's Theory)

According to this theory, the failure or yielding occurs at a point in a member when the strain energy per unit volume in a bi-axial stress system reaches the limiting strain energy (*i.e.* strain energy at the yield point) per unit volume as determined from simple tension test.



This double-decker A 380 has a passenger capacity of 555. Its engines and parts should be robust which can bear high torsional and variable stresses.

We know that strain energy per unit volume in a bi-axial stress system,

$$U_1 = \frac{1}{2E} \left[(\sigma_{t1})^2 + (\sigma_{t2})^2 - \frac{2 \sigma_{t1} \times \sigma_{t2}}{m} \right]$$

and limiting strain energy per unit volume for yielding as determined from simple tension test,

$$U_2 = \frac{1}{2E} \left(\frac{\sigma_{yt}}{F.S.} \right)^2$$

According to the above theory, $U_1 = U_2$.

$$\therefore \frac{1}{2E} \left[(\sigma_{t1})^2 + (\sigma_{t2})^2 - \frac{2 \sigma_{t1} \times \sigma_{t2}}{m} \right] = \frac{1}{2E} \left(\frac{\sigma_{yt}}{F.S.} \right)^2$$

or
$$(\sigma_{t1})^2 + (\sigma_{t2})^2 - \frac{2 \sigma_{t1} \times \sigma_{t2}}{m} = \left(\frac{\sigma_{yt}}{F.S.} \right)^2$$

This theory may be used for ductile materials.

5.14 Maximum Distortion Energy Theory (Hencky and Von Mises Theory)

According to this theory, the failure or yielding occurs at a point in a member when the distortion strain energy (also called shear strain energy) per unit volume in a bi-axial stress system reaches the limiting distortion energy (*i.e.* distortion energy at yield point) per unit volume as determined from a simple tension test. Mathematically, the maximum distortion energy theory for yielding is expressed as

$$(\sigma_{t1})^2 + (\sigma_{t2})^2 - 2\sigma_{t1} \times \sigma_{t2} = \left(\frac{\sigma_{yt}}{F.S.} \right)^2$$

This theory is mostly used for ductile materials in place of maximum strain energy theory.

Note: The maximum distortion energy is the difference between the total strain energy and the strain energy due to uniform stress.

Example 5.16. The load on a bolt consists of an axial pull of 10 kN together with a transverse shear force of 5 kN. Find the diameter of bolt required according to

1. Maximum principal stress theory; 2. Maximum shear stress theory; 3. Maximum principal strain theory; 4. Maximum strain energy theory; and 5. Maximum distortion energy theory.

Take permissible tensile stress at elastic limit = 100 MPa and poisson's ratio = 0.3.

Solution. Given : $P_{t1} = 10 \text{ kN}$; $P_s = 5 \text{ kN}$; $\sigma_{t(el)} = 100 \text{ MPa} = 100 \text{ N/mm}^2$; $1/m = 0.3$

Let $d =$ Diameter of the bolt in mm.

∴ Cross-sectional area of the bolt,

$$A = \frac{\pi}{4} \times d^2 = 0.7854 d^2 \text{ mm}^2$$

We know that axial tensile stress,

$$\sigma_1 = \frac{P_{t1}}{A} = \frac{10}{0.7854 d^2} = \frac{12.73}{d^2} \text{ kN/mm}^2$$

and transverse shear stress,

$$\tau = \frac{P_s}{A} = \frac{5}{0.7854 d^2} = \frac{6.365}{d^2} \text{ kN/mm}^2$$

1. According to maximum principal stress theory

We know that maximum principal stress,

$$\begin{aligned} \sigma_{r1} &= \frac{\sigma_1 + \sigma_2}{2} + \frac{1}{2} \left[\sqrt{(\sigma_1 - \sigma_2)^2 + 4 \tau^2} \right] \\ &= \frac{\sigma_1}{2} + \frac{1}{2} \left[\sqrt{(\sigma_1)^2 + 4 \tau^2} \right] \quad \dots(\because \sigma_2 = 0) \\ &= \frac{12.73}{2 d^2} + \frac{1}{2} \left[\sqrt{\left(\frac{12.73}{d^2}\right)^2 + 4 \left(\frac{6.365}{d^2}\right)^2} \right] \\ &= \frac{6.365}{d^2} + \frac{1}{2} \times \frac{6.365}{d^2} \left[\sqrt{4 + 4} \right] \\ &= \frac{6.365}{d^2} \left[1 + \frac{1}{2} \sqrt{4 + 4} \right] = \frac{15.365}{d^2} \text{ kN/mm}^2 = \frac{15\ 365}{d^2} \text{ N/mm}^2 \end{aligned}$$

According to maximum principal stress theory,

$$\sigma_{t1} = \sigma_{t(el)} \text{ or } \frac{15\ 365}{d^2} = 100$$

∴ $d^2 = 15\ 365/100 = 153.65$ or $d = 12.4 \text{ mm}$ **Ans.**

2. According to maximum shear stress theory

We know that maximum shear stress,

$$\begin{aligned} \tau_{max} &= \frac{1}{2} \left[\sqrt{(\sigma_1 - \sigma_2)^2 + 4 \tau^2} \right] = \frac{1}{2} \left[\sqrt{(\sigma_1)^2 + 4 \tau^2} \right] \quad \dots(\because \sigma_2 = 0) \\ &= \frac{1}{2} \left[\sqrt{\left(\frac{12.73}{d^2}\right)^2 + 4 \left(\frac{6.365}{d^2}\right)^2} \right] = \frac{1}{2} \times \frac{6.365}{d^2} \left[\sqrt{4 + 4} \right] \\ &= \frac{9}{d^2} \text{ kN/mm}^2 = \frac{9000}{d^2} \text{ N/mm}^2 \end{aligned}$$

According to maximum shear stress theory,

$$\tau_{max} = \frac{\sigma_{t(el)}}{2} \text{ or } \frac{9000}{d^2} = \frac{100}{2} = 50$$

∴ $d^2 = 9000 / 50 = 180$ or $d = 13.42 \text{ mm}$ **Ans.**

3. According to maximum principal strain theory

We know that maximum principal stress,

$$\sigma_{11} = \frac{\sigma_1}{2} + \frac{1}{2} \left[\sqrt{(\sigma_1)^2 + 4 \tau^2} \right] = \frac{15\,365}{d^2}$$

...(As calculated before)

and minimum principal stress,

$$\begin{aligned} \sigma_{12} &= \frac{\sigma_1}{2} - \frac{1}{2} \left[\sqrt{(\sigma_1)^2 + 4 \tau^2} \right] \\ &= \frac{12.73}{2 d^2} - \frac{1}{2} \left[\sqrt{\left(\frac{12.73}{d^2} \right)^2 + 4 \left(\frac{6.365}{d^2} \right)^2} \right] \\ &= \frac{6.365}{d^2} - \frac{1}{2} \times \frac{6.365}{d^2} \left[\sqrt{4 + 4} \right] \\ &= \frac{6.365}{d^2} \left[1 - \sqrt{2} \right] = \frac{-2.635}{d^2} \text{ kN/mm}^2 \\ &= \frac{-2635}{d^2} \text{ N/mm}^2 \end{aligned}$$



Front view of a jet engine. The rotors undergo high torsional and bending stresses.

We know that according to maximum principal strain theory,

$$\begin{aligned} \frac{\sigma_{11}}{E} - \frac{\sigma_{12}}{mE} &= \frac{\sigma_{t(el)}}{E} \text{ or } \sigma_{11} - \frac{\sigma_{12}}{m} = \sigma_{t(el)} \\ \therefore \frac{15\,365}{d^2} + \frac{2635 \times 0.3}{d^2} &= 100 \text{ or } \frac{16\,156}{d^2} = 100 \\ d^2 &= 16\,156 / 100 = 161.56 \text{ or } d = 12.7 \text{ mm Ans.} \end{aligned}$$

4. According to maximum strain energy theory

We know that according to maximum strain energy theory,

$$\begin{aligned} (\sigma_{11})^2 + (\sigma_{12})^2 - \frac{2 \sigma_{11} \times \sigma_{12}}{m} &= [\sigma_{t(el)}]^2 \\ \left[\frac{15\,365}{d^2} \right]^2 + \left[\frac{-2635}{d^2} \right]^2 - 2 \times \frac{15\,365}{d^2} \times \frac{-2635}{d^2} \times 0.3 &= (100)^2 \\ \frac{236 \times 10^6}{d^4} + \frac{6.94 \times 10^6}{d^4} + \frac{24.3 \times 10^6}{d^4} &= 10 \times 10^3 \\ \frac{23\,600}{d^4} + \frac{694}{d^4} + \frac{2430}{d^4} &= 1 \text{ or } \frac{26\,724}{d^4} = 1 \\ \therefore d^4 &= 26\,724 \text{ or } d = 12.78 \text{ mm Ans.} \end{aligned}$$

5. According to maximum distortion energy theory

According to maximum distortion energy theory,

$$\begin{aligned} (\sigma_{11})^2 + (\sigma_{12})^2 - 2 \sigma_{11} \times \sigma_{12} &= [\sigma_{t(el)}]^2 \\ \left[\frac{15\,365}{d^2} \right]^2 + \left[\frac{-2635}{d^2} \right]^2 - 2 \times \frac{15\,365}{d^2} \times \frac{-2635}{d^2} &= (100)^2 \\ \frac{236 \times 10^6}{d^4} + \frac{6.94 \times 10^6}{d^4} + \frac{80.97 \times 10^6}{d^4} &= 10 \times 10^3 \\ \frac{23\,600}{d^4} + \frac{694}{d^4} + \frac{8097}{d^4} &= 1 \text{ or } \frac{32\,391}{d^4} = 1 \\ \therefore d^4 &= 32\,391 \text{ or } d = 13.4 \text{ mm Ans.} \end{aligned}$$

Example 5.17. A cylindrical shaft made of steel of yield strength 700 MPa is subjected to static loads consisting of bending moment 10 kN-m and a torsional moment 30 kN-m. Determine the diameter of the shaft using two different theories of failure, and assuming a factor of safety of 2. Take $E = 210$ GPa and poisson's ratio = 0.25.

Solution. Given : $\sigma_{yt} = 700$ MPa = 700 N/mm²; $M = 10$ kN-m = 10×10^6 N-mm ; $T = 30$ kN-m = 30×10^6 N-mm ; $F.S. = 2$; $E = 210$ GPa = 210×10^3 N/mm²; $1/m = 0.25$

Let d = Diameter of the shaft in mm.

First of all, let us find the maximum and minimum principal stresses.

We know that section modulus of the shaft

$$Z = \frac{\pi}{32} \times d^3 = 0.0982 d^3 \text{ mm}^3$$

∴ Bending (tensile) stress due to the bending moment,

$$\sigma_1 = \frac{M}{Z} = \frac{10 \times 10^6}{0.0982 d^3} = \frac{101.8 \times 10^6}{d^3} \text{ N/mm}^2$$

and shear stress due to torsional moment,

$$\tau = \frac{16 T}{\pi d^3} = \frac{16 \times 30 \times 10^6}{\pi d^3} = \frac{152.8 \times 10^6}{d^3} \text{ N/mm}^2$$

We know that maximum principal stress,

$$\begin{aligned} \sigma_{t1} &= \frac{\sigma_1 + \sigma_2}{2} + \frac{1}{2} \left[\sqrt{(\sigma_1 - \sigma_2)^2 + 4 \tau^2} \right] \\ &= \frac{\sigma_1}{2} + \frac{1}{2} \left[\sqrt{(\sigma_1)^2 + 4 \tau^2} \right] \quad \dots (\because \sigma_2 = 0) \\ &= \frac{101.8 \times 10^6}{2d^3} + \frac{1}{2} \left[\sqrt{\left(\frac{101.8 \times 10^6}{d^3} \right)^2 + 4 \left(\frac{152.8 \times 10^6}{d^3} \right)^2} \right] \\ &= \frac{50.9 \times 10^6}{d^3} + \frac{1}{2} \times \frac{10^6}{d^3} \left[\sqrt{(101.8)^2 + 4 (152.8)^2} \right] \\ &= \frac{50.9 \times 10^6}{d^3} + \frac{161 \times 10^6}{d^3} = \frac{211.9 \times 10^6}{d^3} \text{ N/mm}^2 \end{aligned}$$

and minimum principal stress,

$$\begin{aligned} \sigma_{t2} &= \frac{\sigma_1 + \sigma_2}{2} - \frac{1}{2} \left[\sqrt{(\sigma_1 - \sigma_2)^2 + 4 \tau^2} \right] \\ &= \frac{\sigma_1}{2} - \frac{1}{2} \left[\sqrt{(\sigma_1)^2 + 4 \tau^2} \right] \quad \dots (\because \sigma_2 = 0) \\ &= \frac{50.9 \times 10^6}{d^3} - \frac{161 \times 10^6}{d^3} = \frac{-110.1 \times 10^6}{d^3} \text{ N/mm}^2 \end{aligned}$$

Let us now find out the diameter of shaft (d) by considering the maximum shear stress theory and maximum strain energy theory.

1. According to maximum shear stress theory

We know that maximum shear stress,

$$\tau_{max} = \frac{\sigma_{t1} - \sigma_{t2}}{2} = \frac{1}{2} \left[\frac{211.9 \times 10^6}{d^3} + \frac{110.1 \times 10^6}{d^3} \right] = \frac{161 \times 10^6}{d^3}$$

We also know that according to maximum shear stress theory,

$$\tau_{max} = \frac{\sigma_{yt}}{2 F.S.} \quad \text{or} \quad \frac{161 \times 10^6}{d^3} = \frac{700}{2 \times 2} = 175$$

$$\therefore d^3 = 161 \times 10^6 / 175 = 920 \times 10^3 \text{ or } d = 97.2 \text{ mm Ans.}$$

158 ■ A Textbook of Machine Design

Note: The value of maximum shear stress (τ_{max}) may also be obtained by using the relation,

$$\begin{aligned}\tau_{max} &= \frac{1}{2} \left[\sqrt{(\sigma_1)^2 + 4\tau^2} \right] \\ &= \frac{1}{2} \left[\sqrt{\left(\frac{101.8 \times 10^6}{d^3} \right)^2 + 4 \left(\frac{152.8 \times 10^6}{d^3} \right)^2} \right] \\ &= \frac{1}{2} \times \frac{10^6}{d^3} \left[\sqrt{(101.8)^2 + 4(152.8)^2} \right] \\ &= \frac{1}{2} \times \frac{10^6}{d^3} \times 322 = \frac{161 \times 10^6}{d^3} \text{ N/mm}^2 \quad \dots(\text{Same as before})\end{aligned}$$

2. According to maximum strain energy theory

We know that according to maximum strain energy theory,

$$\begin{aligned}\frac{1}{2E} \left[(\sigma_{t1})^2 + (\sigma_{t2})^2 - \frac{2\sigma_{t1} \times \sigma_{t2}}{m} \right] &= \frac{1}{2E} \left(\frac{\sigma_{yt}}{F.S.} \right)^2 \\ \text{or} \quad (\sigma_{t1})^2 + (\sigma_{t2})^2 - \frac{2\sigma_{t1} \times \sigma_{t2}}{m} &= \left(\frac{\sigma_{yt}}{F.S.} \right)^2 \\ \left[\frac{211.9 \times 10^6}{d^3} \right]^2 + \left[\frac{-110.1 \times 10^6}{d^3} \right]^2 - 2 \times \frac{211.9 \times 10^6}{d^3} \times \frac{-110.1 \times 10^6}{d^3} \times 0.25 &= \left(\frac{700}{2} \right)^2 \\ \text{or} \quad \frac{44\,902 \times 10^{12}}{d^6} + \frac{12\,122 \times 10^{12}}{d^6} + \frac{11\,665 \times 10^{12}}{d^6} &= 122\,500 \\ \frac{68\,689 \times 10^{12}}{d^6} &= 122\,500\end{aligned}$$

$$\therefore d^6 = 68\,689 \times 10^{12} / 122\,500 = 0.5607 \times 10^{12} \text{ or } d = 90.8 \text{ mm Ans.}$$

Example 5.18. A mild steel shaft of 50 mm diameter is subjected to a bending moment of 2000 N-m and a torque T . If the yield point of the steel in tension is 200 MPa, find the maximum value of this torque without causing yielding of the shaft according to 1. the maximum principal stress; 2. the maximum shear stress; and 3. the maximum distortion strain energy theory of yielding.

Solution. Given: $d = 50 \text{ mm}$; $M = 2000 \text{ N-m} = 2 \times 10^6 \text{ N-mm}$; $\sigma_{yt} = 200 \text{ MPa} = 200 \text{ N/mm}^2$

Let $T =$ Maximum torque without causing yielding of the shaft, in N-mm.

1. According to maximum principal stress theory

We know that section modulus of the shaft,

$$Z = \frac{\pi}{32} \times d^3 = \frac{\pi}{32} (50)^3 = 12\,273 \text{ mm}^3$$

\therefore Bending stress due to the bending moment,

$$\sigma_1 = \frac{M}{Z} = \frac{2 \times 10^6}{12\,273} = 163 \text{ N/mm}^2$$

and shear stress due to the torque,

$$\tau = \frac{16T}{\pi d^3} = \frac{16T}{\pi (50)^3} = 0.0407 \times 10^{-3} T \text{ N/mm}^2$$

$$\dots \left[\because T = \frac{\pi}{16} \times \tau \times d^3 \right]$$

We know that maximum principal stress,

$$\begin{aligned}\sigma_{t1} &= \frac{\sigma_1}{2} + \frac{1}{2} \left[\sqrt{(\sigma_1)^2 + 4\tau^2} \right] \\ &= \frac{163}{2} + \frac{1}{2} \left[\sqrt{(163)^2 + 4(0.0407 \times 10^{-3} T)^2} \right]\end{aligned}$$

Minimum principal stress,

$$= 81.5 + \sqrt{6642.5 + 1.65 \times 10^{-9} T^2} \text{ N/mm}^2$$

$$\begin{aligned} \sigma_{r2} &= \frac{\sigma_1}{2} - \frac{1}{2} \left[\sqrt{(\sigma_1)^2 + 4 \tau^2} \right] \\ &= \frac{163}{2} - \frac{1}{2} \left[\sqrt{(163)^2 + 4 (0.0407 \times 10^{-3} T)^2} \right] \\ &= 81.5 - \sqrt{6642.5 + 1.65 \times 10^{-9} T^2} \text{ N/mm}^2 \end{aligned}$$

and maximum shear stress,

$$\begin{aligned} \tau_{max} &= \frac{1}{2} \left[\sqrt{(\sigma_1)^2 + 4 \tau^2} \right] = \frac{1}{2} \left[\sqrt{(163)^2 + 4 (0.0407 \times 10^{-3} T)^2} \right] \\ &= \sqrt{6642.5 + 1.65 \times 10^{-9} T^2} \text{ N/mm}^2 \end{aligned}$$

We know that according to maximum principal stress theory,

$$\begin{aligned} \sigma_{f1} &= \sigma_{yt} && \dots(\text{Taking } F.S. = 1) \\ \therefore 81.5 + \sqrt{6642.5 + 1.65 \times 10^{-9} T^2} &= 200 \\ 6642.5 + 1.65 \times 10^{-9} T^2 &= (200 - 81.5)^2 = 14\,042 \\ T^2 &= \frac{14\,042 - 6642.5}{1.65 \times 10^{-9}} = 4485 \times 10^9 \\ \text{or } T &= 2118 \times 10^3 \text{ N-mm} = 2118 \text{ N-m } \mathbf{Ans.} \end{aligned}$$

2. According to maximum shear stress theory

We know that according to maximum shear stress theory,

$$\begin{aligned} \tau_{max} &= \tau_{yt} = \frac{\sigma_{yt}}{2} \\ \therefore \sqrt{6642.5 + 1.65 \times 10^{-9} T^2} &= \frac{200}{2} = 100 \\ 6642.5 + 1.65 \times 10^{-9} T^2 &= (100)^2 = 10\,000 \\ T^2 &= \frac{10\,000 - 6642.5}{1.65 \times 10^{-9}} = 2035 \times 10^9 \\ \therefore T &= 1426 \times 10^3 \text{ N-mm} = 1426 \text{ N-m } \mathbf{Ans.} \end{aligned}$$

3. According to maximum distortion strain energy theory

We know that according to maximum distortion strain energy theory

$$\begin{aligned} (\sigma_{r1})^2 + (\sigma_{r2})^2 - \sigma_{r1} \times \sigma_{r2} &= (\sigma_{yt})^2 \\ \left[81.5 + \sqrt{6642.5 + 1.65 \times 10^{-9} T^2} \right]^2 + \left[81.5 - \sqrt{6642.5 + 1.65 \times 10^{-9} T^2} \right]^2 \\ - \left[81.5 + \sqrt{6642.5 + 1.65 \times 10^{-9} T^2} \right] \left[81.5 - \sqrt{6642.5 + 1.65 \times 10^{-9} T^2} \right] &= (200)^2 \\ 2 \left[(81.5)^2 + 6642.5 + 1.65 \times 10^{-9} T^2 \right] - \left[(81.5)^2 - 6642.5 + 1.65 \times 10^{-9} T^2 \right] &= (200)^2 \\ (81.5)^2 + 3 \times 6642.5 + 3 \times 1.65 \times 10^{-9} T^2 &= (200)^2 \\ 26\,570 + 4.95 \times 10^{-9} T^2 &= 40\,000 \\ T^2 &= \frac{40\,000 - 26\,570}{4.95 \times 10^{-9}} = 2713 \times 10^9 \\ \therefore T &= 1647 \times 10^3 \text{ N-mm} = 1647 \text{ N-m } \mathbf{Ans.} \end{aligned}$$

5.15 Eccentric Loading - Direct and Bending Stresses Combined

An external load, whose line of action is parallel but does not coincide with the centroidal axis of the machine component, is known as an *eccentric load*. The distance between the centroidal axis of the machine component and the eccentric load is called *eccentricity* and is generally denoted by e . The examples of eccentric loading, from the subject point of view, are C-clamps, punching machines, brackets, offset connecting links etc.

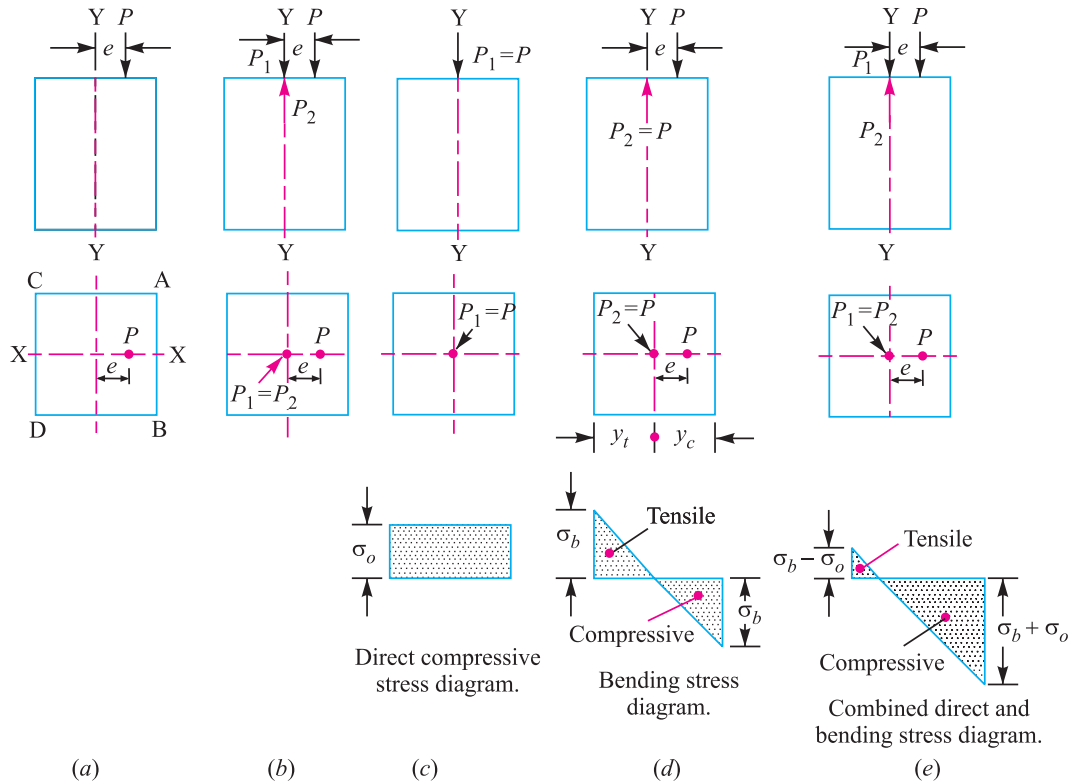

Fig. 5.19. Eccentric loading.

Consider a short prismatic bar subjected to a compressive load P acting at an eccentricity of e as shown in Fig. 5.19 (a).

Let us introduce two forces P_1 and P_2 along the centre line or neutral axis equal in magnitude to P , without altering the equilibrium of the bar as shown in Fig. 5.19 (b). A little consideration will show that the force P_1 will induce a direct compressive stress over the entire cross-section of the bar, as shown in Fig. 5.19 (c).

The magnitude of this direct compressive stress is given by

$$\sigma_o = \frac{P_1}{A} \text{ or } \frac{P}{A}, \text{ where } A \text{ is the cross-sectional area of the bar.}$$

The forces P_1 and P_2 will form a couple equal to $P \times e$ which will cause bending stress. This bending stress is compressive at the edge AB and tensile at the edge CD , as shown in Fig. 5.19 (d). The magnitude of bending stress at the edge AB is given by

$$\sigma_b = \frac{P \cdot e \cdot y_c}{I} \text{ (compressive)}$$

and bending stress at the edge CD ,

$$\sigma_b = \frac{P \cdot e \cdot y_t}{I} \text{ (tensile)}$$

where y_c and y_t = Distances of the extreme fibres on the compressive and tensile sides, from the neutral axis respectively, and
 I = Second moment of area of the section about the neutral axis *i.e.* Y-axis.

According to the principle of superposition, the maximum or the resultant compressive stress at the edge AB,

$$\sigma_c = \frac{P \cdot e \cdot y_c}{I} + \frac{P}{A} = \frac{M}{Z} + \frac{P}{A} = \sigma_b + \sigma_o$$

and the maximum or resultant tensile stress at the edge CD,

$$\sigma_t = \frac{P \cdot e \cdot y_t}{I} - \frac{P}{A} = \frac{M}{Z} - \frac{P}{A} = \sigma_b - \sigma_o$$

The resultant compressive and tensile stress diagram is shown in Fig. 5.19 (e).

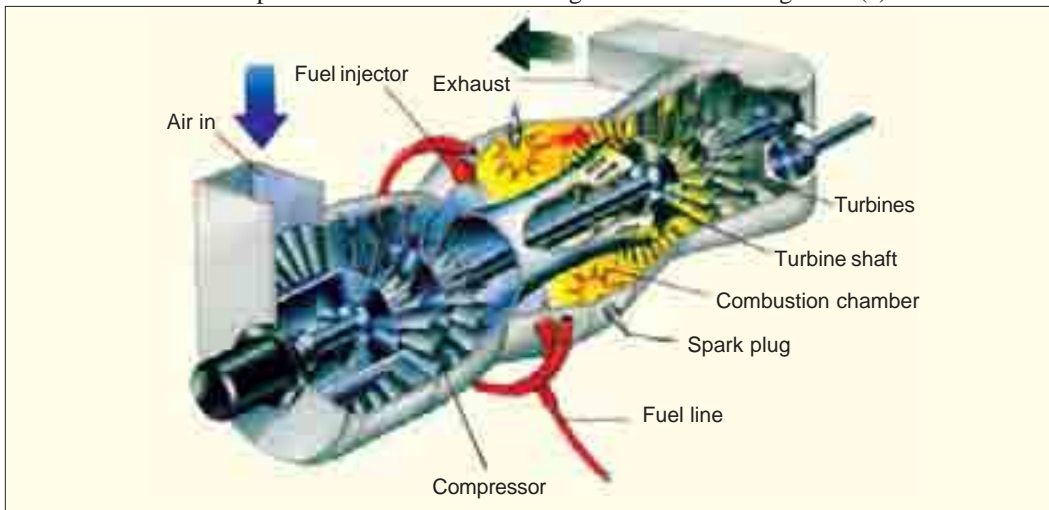

In a gas-turbine system, a compressor forces air into a combustion chamber. There, it mixes with fuel. The mixture is ignited by a spark. Hot gases are produced when the fuel burns. They expand and drive a series of fan blades called a turbine.

Note : This picture is given as additional information and is not a direct example of the current chapter.

Notes: 1. When the member is subjected to a tensile load, then the above equations may be used by interchanging the subscripts *c* and *t*.

2. When the direct stress σ_o is greater than or equal to bending stress σ_b , then the compressive stress shall be present all over the cross-section.

3. When the direct stress σ_o is less than the bending stress σ_b , then the tensile stress will occur in the left hand portion of the cross-section and compressive stress on the right hand portion of the cross-section. In Fig. 5.19, the stress diagrams are drawn by taking σ_o less than σ_b .

In case the eccentric load acts with eccentricity about two axes, as shown in Fig. 5.20, then the total stress at the extreme fibre

$$= \frac{P}{A} \pm \frac{P \cdot e_x \cdot x}{I_{xx}} \pm \frac{P \cdot e_y \cdot y}{I_{yy}}$$

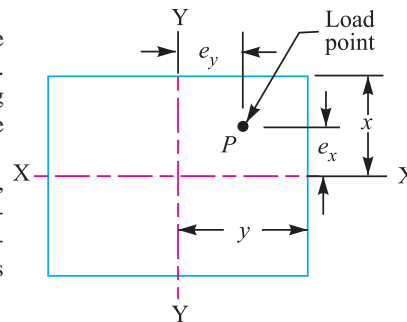

Fig. 5.20. Eccentric load with eccentricity about two axes.

* We know that bending moment, $M = P \cdot e$ and section modulus, $Z = \frac{I}{y} = \frac{I}{y_c \text{ or } y_t}$

∴ Bending stress, $\sigma_b = M / Z$

Example 5.19. A rectangular strut is 150 mm wide and 120 mm thick. It carries a load of 180 kN at an eccentricity of 10 mm in a plane bisecting the thickness as shown in Fig. 5.21. Find the maximum and minimum intensities of stress in the section.

Solution. Given : $b = 150 \text{ mm}$; $d = 120 \text{ mm}$; $P = 180 \text{ kN}$
 $= 180 \times 10^3 \text{ N}$; $e = 10 \text{ mm}$

We know that cross-sectional area of the strut,

$$A = b.d = 150 \times 120 = 18 \times 10^3 \text{ mm}^2$$

∴ Direct compressive stress,

$$\sigma_o = \frac{P}{A} = \frac{180 \times 10^3}{18 \times 10^3} = 10 \text{ N/mm}^2 = 10 \text{ MPa}$$

Section modulus for the strut,

$$Z = \frac{I_{YY}}{y} = \frac{d \cdot b^3 / 12}{b/2} = \frac{d \cdot b^2}{6} = \frac{120 (150)^2}{6} = 450 \times 10^3 \text{ mm}^3$$

Bending moment, $M = P.e = 180 \times 10^3 \times 10 = 1.8 \times 10^6 \text{ N-mm}$

$$\therefore \text{Bending stress, } \sigma_b = \frac{M}{Z} = \frac{1.8 \times 10^6}{450 \times 10^3} = 4 \text{ N/mm}^2 = 4 \text{ MPa}$$

Since σ_o is greater than σ_b , therefore the entire cross-section of the strut will be subjected to compressive stress. The maximum intensity of compressive stress will be at the edge AB and minimum at the edge CD.

$$\therefore \text{Maximum intensity of compressive stress at the edge AB} = \sigma_o + \sigma_b = 10 + 4 = 14 \text{ MPa Ans.}$$

and minimum intensity of compressive stress at the edge CD

$$= \sigma_o - \sigma_b = 10 - 4 = 6 \text{ MPa Ans.}$$

Example 5.20. A hollow circular column of external diameter 250 mm and internal diameter 200 mm, carries a projecting bracket on which a load of 20 kN rests, as shown in Fig. 5.22. The centre of the load from the centre of the column is 500 mm. Find the stresses at the sides of the column.

Solution. Given : $D = 250 \text{ mm}$; $d = 200 \text{ mm}$;
 $P = 20 \text{ kN} = 20 \times 10^3 \text{ N}$; $e = 500 \text{ mm}$

We know that cross-sectional area of column,

$$A = \frac{\pi}{4} (D^2 - d^2) = \frac{\pi}{4} [(250)^2 - (200)^2] = 17\,674 \text{ mm}^2$$

∴ Direct compressive stress,

$$\sigma_o = \frac{P}{A} = \frac{20 \times 10^3}{17\,674} = 1.13 \text{ N/mm}^2 = 1.13 \text{ MPa}$$

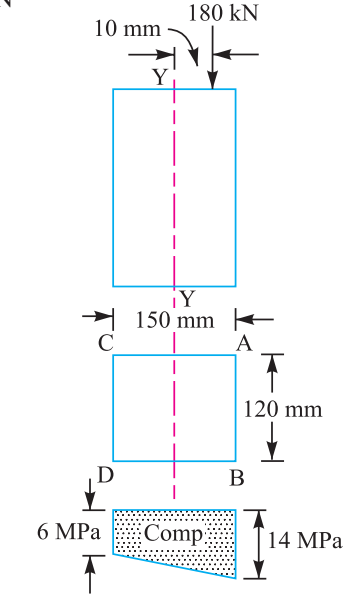
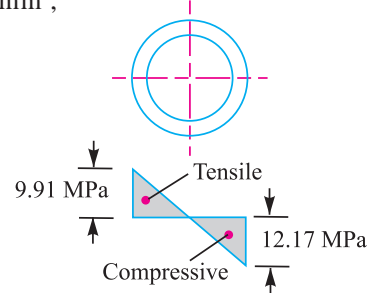
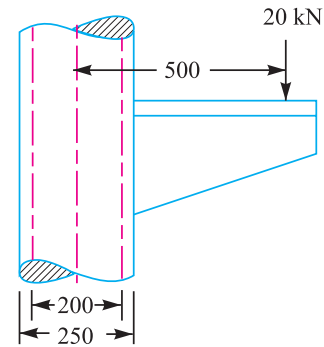

Fig. 5.21



All dimensions in mm.

Fig. 5.22

Section modulus for the column,

$$Z = \frac{I}{y} = \frac{\frac{\pi}{64} [D^4 - d^4]}{D/2} = \frac{\pi}{64} \frac{[(250)^4 - (200)^4]}{250/2} = 905.8 \times 10^3 \text{ mm}^3$$

Bending moment,

$$M = P \cdot e = 20 \times 10^3 \times 500 = 10 \times 10^6 \text{ N-mm}$$

∴ Bending stress,

$$\sigma_b = \frac{M}{Z} = \frac{10 \times 10^6}{905.8 \times 10^3} = 11.04 \text{ N/mm}^2 = 11.04 \text{ MPa}$$

Since σ_o is less than σ_b , therefore right hand side of the column will be subjected to compressive stress and the left hand side of the column will be subjected to tensile stress.

∴ Maximum compressive stress,

$$\sigma_c = \sigma_b + \sigma_o = 11.04 + 1.13 = 12.17 \text{ MPa Ans.}$$

and maximum tensile stress,

$$\sigma_t = \sigma_b - \sigma_o = 11.04 - 1.13 = 9.91 \text{ MPa Ans.}$$

Example 5.21. A masonry pier of width 4 m and thickness 3 m, supports a load of 30 kN as shown in Fig. 5.23. Find the stresses developed at each corner of the pier.

Solution. Given: $b = 4 \text{ m}$; $d = 3 \text{ m}$; $P = 30 \text{ kN}$; $e_x = 0.5 \text{ m}$; $e_y = 1 \text{ m}$

We know that cross-sectional area of the pier,

$$A = b \times d = 4 \times 3 = 12 \text{ m}^2$$

Moment of inertia of the pier about X-axis,

$$I_{XX} = \frac{b \cdot d^3}{12} = \frac{4 \times 3^3}{12} = 9 \text{ m}^4$$

and moment of inertia of the pier about Y-axis,

$$I_{YY} = \frac{d \cdot b^3}{12} = \frac{3 \times 4^3}{12} = 16 \text{ m}^4$$

Distance between X-axis and the corners A and B,

$$x = 3 / 2 = 1.5 \text{ m}$$

Distance between Y-axis and the corners A and C,

$$y = 4 / 2 = 2 \text{ m}$$

We know that stress at corner A,

$$\sigma_A = \frac{P}{A} + \frac{P \cdot e_x \cdot x}{I_{XX}} + \frac{P \cdot e_y \cdot y}{I_{YY}}$$

... [∵ At A, both x and y are +ve]

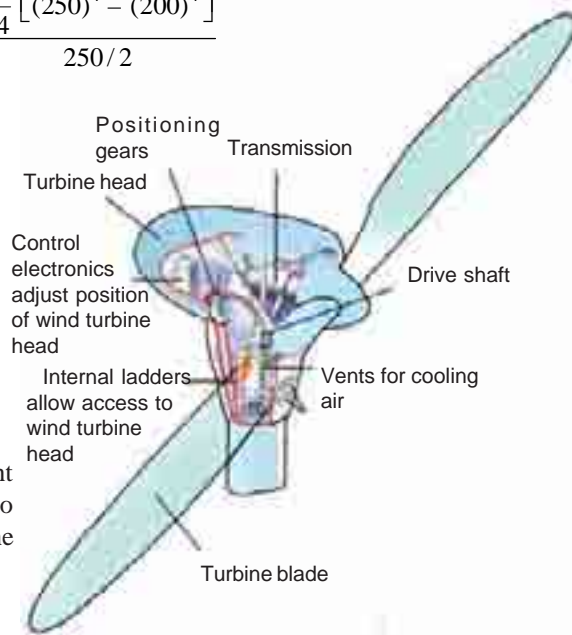

Wind turbine.

Note : This picture is given as additional information and is not a direct example of the current chapter.

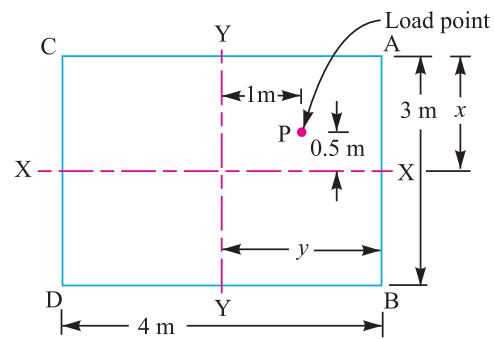

Fig. 5.23

$$= \frac{30}{12} + \frac{30 \times 0.5 \times 1.5}{9} + \frac{30 \times 1 \times 2}{16}$$

$$= 2.5 + 2.5 + 3.75 = 8.75 \text{ kN/m}^2 \text{ Ans.}$$

Similarly stress at corner B,

$$\sigma_B = \frac{P}{A} + \frac{P \cdot e_x \cdot x}{I_{XX}} - \frac{P \cdot e_y \cdot y}{I_{YY}} \quad \dots [\because \text{At B, } x \text{ is +ve and } y \text{ is -ve}]$$

$$= \frac{30}{12} + \frac{30 \times 0.5 \times 1.5}{9} - \frac{30 \times 1 \times 2}{16}$$

$$= 2.5 + 2.5 - 3.75 = 1.25 \text{ kN/m}^2 \text{ Ans.}$$

Stress at corner C,

$$\sigma_C = \frac{P}{A} - \frac{P \cdot e_x \cdot x}{I_{XX}} + \frac{P \cdot e_y \cdot y}{I_{YY}} \quad \dots [\text{At C, } x \text{ is -ve and } y \text{ is +ve}]$$

$$= \frac{30}{12} - \frac{30 \times 0.5 \times 1.5}{9} + \frac{30 \times 1 \times 2}{16}$$

$$= 2.5 - 2.5 + 3.75 = 3.75 \text{ kN/m}^2 \text{ Ans.}$$

and stress at corner D,

$$\sigma_D = \frac{P}{A} - \frac{P \cdot e_x \cdot x}{I_{XX}} - \frac{P \cdot e_y \cdot y}{I_{YY}} \quad \dots [\text{At D, both } x \text{ and } y \text{ are -ve}]$$

$$= \frac{30}{12} - \frac{30 \times 0.5 \times 1.5}{9} - \frac{30 \times 1 \times 2}{16}$$

$$= 2.5 - 2.5 - 3.75 = -3.75 \text{ kN/m}^2 = 3.75 \text{ kN/m}^2 \text{ (tensile) Ans.}$$

Example 5.22. A mild steel link, as shown in Fig. 5.24 by full lines, transmits a pull of 80 kN. Find the dimensions b and t if $b = 3t$. Assume the permissible tensile stress as 70 MPa. If the original link is replaced by an unsymmetrical one, as shown by dotted lines in Fig. 5.24, having the same thickness t , find the depth b_1 , using the same permissible stress as before.

Solution. Given : $P = 80 \text{ kN}$
 $= 80 \times 10^3 \text{ N}$; $\sigma_t = 70 \text{ MPa} = 70 \text{ N/mm}^2$

Fig. 5.24

When the link is in the position shown by full lines in Fig. 5.24, the area of cross-section,

$$A = b \times t = 3t \times t = 3t^2 \quad \dots (\because b = 3t)$$

We know that tensile load (P),

$$80 \times 10^3 = \sigma_t \times A = 70 \times 3t^2 = 210 t^2$$

$$\therefore t^2 = 80 \times 10^3 / 210 = 381 \text{ or } t = 19.5 \text{ say } 20 \text{ mm Ans.}$$

and $b = 3t = 3 \times 20 = 60 \text{ mm Ans.}$

When the link is in the position shown by dotted lines, it will be subjected to direct stress as well as bending stress. We know that area of cross-section,

$$A_1 = b_1 \times t$$

∴ Direct tensile stress,

$$\sigma_o = \frac{P}{A} = \frac{P}{b_1 \times t}$$

and bending stress,
$$\sigma_b = \frac{M}{Z} = \frac{P \cdot e}{Z} = \frac{6 P \cdot e}{t (b_1)^2} \quad \dots \left(\because Z = \frac{t (b_1)^2}{6} \right)$$

∴ Total stress due to eccentric loading

$$= \sigma_b + \sigma_o = \frac{6 P \cdot e}{t (b_1)^2} + \frac{P}{b_1 \times t} = \frac{P}{t \cdot b_1} \left(\frac{6 e}{b_1} + 1 \right)$$

Since the permissible tensile stress is the same as 70 N/mm², therefore

$$70 = \frac{80 \times 10^3}{20 b_1} \left(\frac{6 \times b_1}{b_1 \times 2} + 1 \right) = \frac{16 \times 10^3}{b_1} \quad \dots \left(\because \text{Eccentricity, } e = \frac{b_1}{2} \right)$$

∴
$$b_1 = 16 \times 10^3 / 70 = 228.6 \text{ say } 230 \text{ mm Ans.}$$

Example 5.23. A cast-iron link, as shown in Fig. 5.25, is to carry a load of 20 kN. If the tensile and compressive stresses in the link are not to exceed 25 MPa and 80 MPa respectively, obtain the dimensions of the cross-section of the link at the middle of its length.

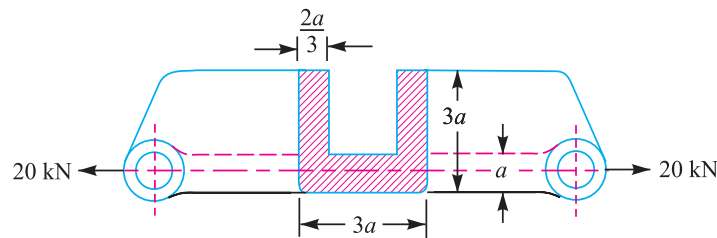

Fig. 5.25

Solution. Given : $P = 20 \text{ kN} = 20 \times 10^3 \text{ N}$; $\sigma_{t(max)} = 25 \text{ MPa} = 25 \text{ N/mm}^2$; $\sigma_{c(max)} = 80 \text{ MPa} = 80 \text{ N/mm}^2$

Since the link is subjected to eccentric loading, therefore there will be direct tensile stress as well as bending stress. The bending stress at the bottom of the link is tensile and in the upper portion is compressive.

We know that cross-sectional area of the link,

$$A = 3a \times a + 2 \times \frac{2a}{3} \times 2a = 5.67 a^2 \text{ mm}^2$$

∴ Direct tensile stress,

$$\sigma_o = \frac{P}{A} = \frac{20 \times 10^3}{5.67 a^2} = \frac{3530}{a^2} \text{ N/mm}^2$$

Now let us find the position of centre of gravity (or neutral axis) in order to find the bending stresses.

Let \bar{y} = Distance of neutral axis (N.A.) from the bottom of the link as shown in Fig. 5.26.

$$\bar{y} = \frac{3a^2 \times \frac{a}{2} + 2 \times \frac{4a^2}{3} \times 2a}{5.67 a^2} = 1.2 a \text{ mm}$$

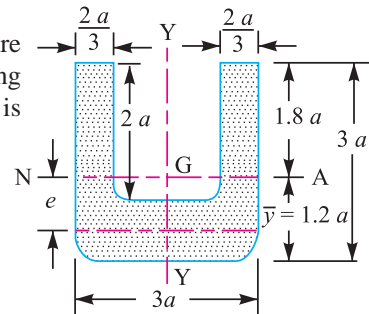

Fig. 5.26

166 ■ A Textbook of Machine Design

Moment of inertia about N.A.,

$$I = \left[\frac{3a \times a^3}{12} + 3a^2 (1.2a - 0.5a)^2 \right] + 2 \left[\frac{\frac{2}{3}a \times (2a)^3}{12} + \frac{4a^2}{3} (2a - 1.2a)^2 \right]$$

$$= (0.25 a^4 + 1.47 a^4) + 2 (0.44a^4 + 0.85 a^4) = 4.3 a^4 \text{ mm}^4$$

Distance of N.A. from the bottom of the link,

$$y_t = \bar{y} = 1.2 a \text{ mm}$$

Distance of N.A. from the top of the link,

$$y_c = 3 a - 1.2 a = 1.8 a \text{ mm}$$

Eccentricity of the load (*i.e.* distance of N.A. from the point of application of the load),

$$e = 1.2 a - 0.5 a = 0.7 a \text{ mm}$$

We know that bending moment exerted on the section,

$$M = P.e = 20 \times 10^3 \times 0.7 a = 14 \times 10^3 a \text{ N-mm}$$

∴ Tensile stress in the bottom of the link,

$$\sigma_t = \frac{M}{Z_t} = \frac{M}{I/y_t} = \frac{M \cdot y_t}{I} = \frac{14 \times 10^3 a \times 1.2 a}{4.3 a^4} = \frac{3907}{a^2}$$

and compressive stress in the top of the link,

$$\sigma_c = \frac{M}{Z_c} = \frac{M}{I/y_c} = \frac{M \cdot y_c}{I} = \frac{14 \times 10^3 a \times 1.8 a}{4.3 a^4} = \frac{5860}{a^2}$$

We know that maximum tensile stress [$\sigma_{t(max)}$],

$$25 = \sigma_t + \sigma_c = \frac{3907}{a^2} + \frac{5860}{a^2} = \frac{9767}{a^2}$$

$$\therefore a^2 = 9767 / 25 = 390.7 \quad \text{or} \quad a = 19.76 \text{ mm} \quad \dots(i)$$

and maximum compressive stress [$\sigma_{c(max)}$],

$$80 = \sigma_c - \sigma_0 = \frac{5860}{a^2} - \frac{3530}{a^2} = \frac{2330}{a^2}$$

$$\therefore a^2 = 2330 / 80 = 29.12 \quad \text{or} \quad a = 5.4 \text{ mm} \quad \dots(ii)$$

We shall take the larger of the two values, *i.e.*

$$a = 19.76 \text{ mm} \text{ Ans.}$$

Example 5.24. A horizontal pull $P = 5 \text{ kN}$ is exerted by the belting on one of the cast iron wall brackets which carry a factory shafting. At a point 75 mm from the wall, the bracket has a T-section as shown in Fig. 5.27. Calculate the maximum stresses in the flange and web of the bracket due to the pull.

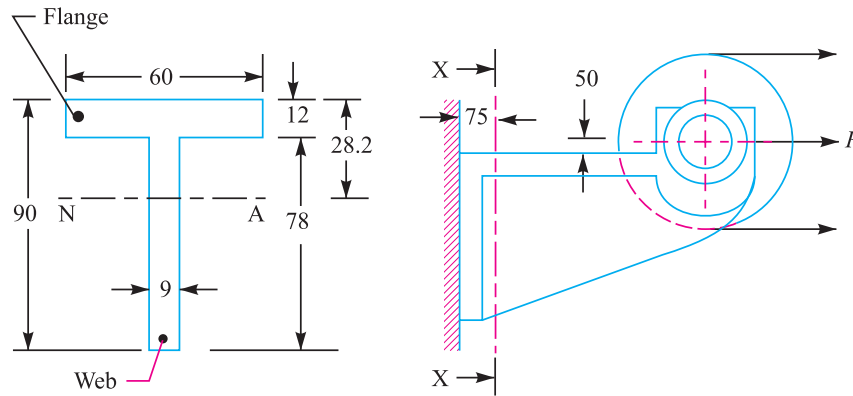

All dimensions in mm.

Fig. 5.27

Solution. Given : Horizontal pull, $P = 5 \text{ kN} = 5000 \text{ N}$

Since the section is subjected to eccentric loading, therefore there will be direct tensile stress as well as bending stress. The bending stress at the flange is tensile and in the web is compressive.

We know that cross-sectional area of the section,

$$A = 60 \times 12 + (90 - 12)9 = 720 + 702 = 1422 \text{ mm}^2$$

$$\therefore \text{Direct tensile stress, } \sigma_0 = \frac{P}{A} = \frac{5000}{1422} = 3.51 \text{ N/mm}^2 = 3.51 \text{ MPa}$$

Now let us find the position of neutral axis in order to determine the bending stresses. The neutral axis passes through the centre of gravity of the section.

Let \bar{y} = Distance of centre of gravity (*i.e.* neutral axis) from top of the flange.

$$\therefore \bar{y} = \frac{60 \times 12 \times \frac{12}{2} + 78 \times 9 \left(12 + \frac{78}{2}\right)}{720 + 702} = 28.2 \text{ mm}$$

Moment of inertia of the section about N.A.,

$$I = \left[\frac{60 (12)^3}{12} + 720 (28.2 - 6)^2 \right] + \left[\frac{9 (78)^3}{12} + 702 (51 - 28.2)^2 \right]$$

$$= (8640 + 354\ 845) + (355\ 914 + 364\ 928) = 1\ 084\ 327 \text{ mm}^4$$



This picture shows a reconnaissance helicopter of air force. Its dark complexion absorbs light that falls on its surface. The flat and sharp edges deflect radar waves and they do not return back to the radar. These factors make it difficult to detect the helicopter.

Note : This picture is given as additional information and is not a direct example of the current chapter.

Distance of N.A. from the top of the flange,

$$y_t = \bar{y} = 28.2 \text{ mm}$$

Distance of N.A. from the bottom of the web,

$$y_c = 90 - 28.2 = 61.8 \text{ mm}$$

Distance of N.A. from the point of application of the load (*i.e.* eccentricity of the load),

$$e = 50 + 28.2 = 78.2 \text{ mm}$$

We know that bending moment exerted on the section,

$$M = P \times e = 5000 \times 78.2 = 391 \times 10^3 \text{ N-mm}$$

∴ Tensile stress in the flange,

$$\begin{aligned} \sigma_t &= \frac{M}{Z_t} = \frac{M}{I/y_t} = \frac{M \cdot y_t}{I} = \frac{391 \times 10^3 \times 28.2}{1\,084\,327} = 10.17 \text{ N/mm}^2 \\ &= 10.17 \text{ MPa} \end{aligned}$$

and compressive stress in the web,

$$\begin{aligned} \sigma_c &= \frac{M}{Z_c} = \frac{M}{I/y_c} = \frac{M \cdot y_c}{I} = \frac{391 \times 10^3 \times 61.8}{1\,084\,327} = 22.28 \text{ N/mm}^2 \\ &= 22.28 \text{ MPa} \end{aligned}$$

We know that maximum tensile stress in the flange,

$$\sigma_{t(max)} = \sigma_b + \sigma_o = \sigma_t + \sigma_o = 10.17 + 3.51 = 13.68 \text{ MPa Ans.}$$

and maximum compressive stress in the flange,

$$\sigma_{c(max)} = \sigma_b - \sigma_o = \sigma_c - \sigma_o = 22.28 - 3.51 = 18.77 \text{ MPa Ans.}$$

Example 5.25. A mild steel bracket as shown in Fig. 5.28, is subjected to a pull of 6000 N acting at 45° to its horizontal axis. The bracket has a rectangular section whose depth is twice the thickness. Find the cross-sectional dimensions of the bracket, if the permissible stress in the material of the bracket is limited to 60 MPa.

Solution. Given : $P = 6000 \text{ N}$; $\theta = 45^\circ$; $\sigma = 60 \text{ MPa} = 60 \text{ N/mm}^2$

Let t = Thickness of the section in mm, and

b = Depth or width of the section = $2t$... (Given)

We know that area of cross-section,

$$A = b \times t = 2t \times t = 2t^2 \text{ mm}^2$$

and section modulus,

$$\begin{aligned} Z &= \frac{t \times b^2}{6} \\ &= \frac{t (2t)^2}{6} \\ &= \frac{4t^3}{6} \text{ mm}^3 \end{aligned}$$

Horizontal component of the load,

$$\begin{aligned} P_H &= 6000 \cos 45^\circ \\ &= 6000 \times 0.707 \\ &= 4242 \text{ N} \end{aligned}$$

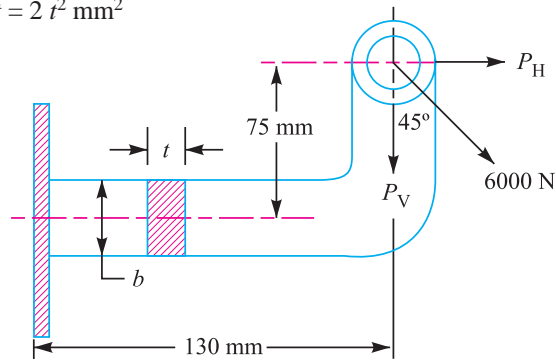

Fig. 5.28

∴ Bending moment due to horizontal

component of the load,

$$M_H = P_H \times 75 = 4242 \times 75 = 318\,150 \text{ N-mm}$$

A little consideration will show that the bending moment due to the horizontal component of the load induces tensile stress on the upper surface of the bracket and compressive stress on the lower surface of the bracket.

∴ Maximum bending stress on the upper surface due to horizontal component,

$$\begin{aligned} \sigma_{bH} &= \frac{M_H}{Z} \\ &= \frac{318\,150 \times 6}{4t^3} \end{aligned}$$

$$= \frac{477\,225}{t^3} \text{ N/mm}^2 \text{ (tensile)}$$

Vertical component of the load,

$$P_V = 6000 \sin 45^\circ = 6000 \times 0.707 = 4242 \text{ N}$$

∴ Direct stress due to vertical component,

$$\sigma_{oV} = \frac{P_V}{A} = \frac{4242}{2t^2} = \frac{2121}{t^2} \text{ N/mm}^2 \text{ (tensile)}$$

Bending moment due to vertical component of the load,

$$M_V = P_V \times 130 = 4242 \times 130 = 551\,460 \text{ N-mm}$$

This bending moment induces tensile stress on the upper surface and compressive stress on the lower surface of the bracket.

∴ Maximum bending stress on the upper surface due to vertical component,

$$\sigma_{bV} = \frac{M_V}{Z} = \frac{551\,460 \times 6}{4t^3} = \frac{827\,190}{t^3} \text{ N/mm}^2 \text{ (tensile)}$$

and total tensile stress on the upper surface of the bracket,

$$\sigma = \frac{477\,225}{t^3} + \frac{2121}{t^2} + \frac{827\,190}{t^3} = \frac{1\,304\,415}{t^3} + \frac{2121}{t^2}$$

Since the permissible stress (σ) is 60 N/mm², therefore

$$\frac{1\,304\,415}{t^3} + \frac{2121}{t^2} = 60 \text{ or } \frac{21\,740}{t^3} + \frac{35.4}{t^2} = 1$$

∴ $t = 28.4 \text{ mm Ans.}$... (By hit and trial)

and

$$b = 2t = 2 \times 28.4 = 56.8 \text{ mm Ans.}$$

Example 5.26. A C-clamp as shown in Fig. 5.29, carries a load $P = 25 \text{ kN}$. The cross-section of the clamp at X-X is rectangular having width equal to twice thickness. Assuming that the clamp is made of steel casting with an allowable stress of 100 MPa, find its dimensions. Also determine the stresses at sections Y-Y and Z-Z.

Solution. Given : $P = 25 \text{ kN} = 25 \times 10^3 \text{ N}$; $\sigma_{t(max)} = 100 \text{ MPa} = 100 \text{ N/mm}^2$

Dimensions at X-X

Let

t = Thickness of the section at X-X in mm, and

b = Width of the section at X-X in mm = $2t$... (Given)

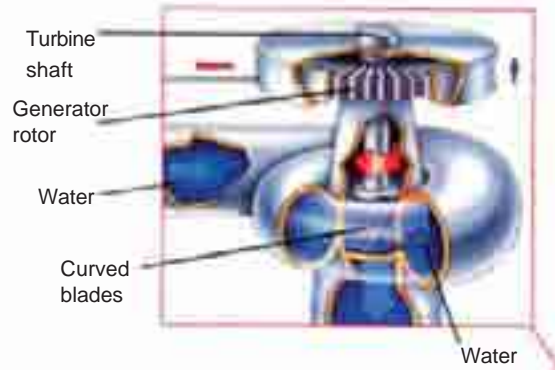

Schematic of a hydrel turbine.

Note : This picture is given as additional information and is not a direct example of the current chapter.

170 ■ A Textbook of Machine Design

We know that cross-sectional area at X-X,

$$A = b \times t = 2t \times t = 2t^2 \text{ mm}^2$$

∴ Direct tensile stress at X-X,

$$\begin{aligned} \sigma_o &= \frac{P}{A} = \frac{25 \times 10^3}{2t^2} \\ &= \frac{12.5 \times 10^3}{t^2} \text{ N/mm}^2 \end{aligned}$$

Bending moment at X-X due to the load P,

$$\begin{aligned} M &= P \times e = 25 \times 10^3 \times 140 \\ &= 3.5 \times 10^6 \text{ N-mm} \end{aligned}$$

Section modulus,
$$Z = \frac{t \cdot b^2}{6} = \frac{t(2t)^2}{6} = \frac{4t^3}{6} \text{ mm}^3$$

... (∵ $b = 2t$)

∴ Bending stress at X-X,

$$\sigma_b = \frac{M}{Z} = \frac{3.5 \times 10^6 \times 6}{4t^3} = \frac{5.25 \times 10^6}{t^3} \text{ N/mm}^2 \text{ (tensile)}$$

We know that the maximum tensile stress [$\sigma_{t(max)}$],

$$100 = \sigma_o + \sigma_b = \frac{12.5 \times 10^3}{t^2} + \frac{5.25 \times 10^6}{t^3}$$

or
$$\frac{125}{t^2} + \frac{52.5 \times 10^3}{t^3} - 1 = 0$$

∴
$$t = 38.5 \text{ mm Ans.}$$

...(By hit and trial)

and

$$b = 2t = 2 \times 38.5 = 77 \text{ mm Ans.}$$

Stresses at section Y-Y

Since the cross-section of frame is uniform throughout, therefore cross-sectional area of the frame at section Y-Y,

$$A = b \sec 45^\circ \times t = 77 \times 1.414 \times 38.5 = 4192 \text{ mm}^2$$

Component of the load perpendicular to the section

$$= P \cos 45^\circ = 25 \times 10^3 \times 0.707 = 17\,675 \text{ N}$$

This component of the load produces uniform tensile stress over the section.

∴ Uniform tensile stress over the section,

$$\sigma = 17\,675 / 4192 = 4.2 \text{ N/mm}^2 = 4.2 \text{ MPa}$$

Component of the load parallel to the section

$$= P \sin 45^\circ = 25 \times 10^3 \times 0.707 = 17\,675 \text{ N}$$

This component of the load produces uniform shear stress over the section.

∴ Uniform shear stress over the section,

$$\tau = 17\,675 / 4192 = 4.2 \text{ N/mm}^2 = 4.2 \text{ MPa}$$

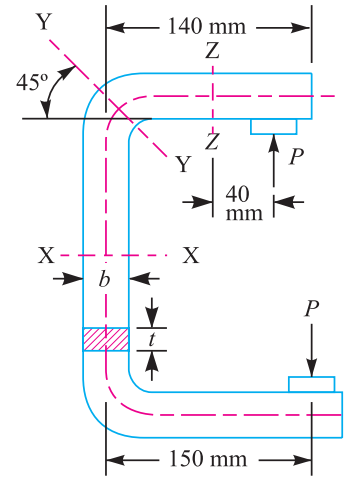

Fig. 5.29

We know that section modulus,

$$Z = \frac{t (b \sec 45^\circ)^2}{6} = \frac{38.5 (77 \times 1.414)^2}{6} = 76 \times 10^3 \text{ mm}^3$$

Bending moment due to load (P) over the section $Y-Y$,

$$M = 25 \times 10^3 \times 140 = 3.5 \times 10^6 \text{ N-mm}$$

∴ Bending stress over the section,

$$\sigma_b = \frac{M}{Z} = \frac{3.5 \times 10^6}{76 \times 10^3} = 46 \text{ N/mm}^2 = 46 \text{ MPa}$$

Due to bending, maximum tensile stress at the inner corner and the maximum compressive stress at the outer corner is produced.

∴ Maximum tensile stress at the inner corner,

$$\sigma_t = \sigma_b + \sigma_o = 46 + 4.2 = 50.2 \text{ MPa}$$

and maximum compressive stress at the outer corner,

$$\sigma_c = \sigma_b - \sigma_o = 46 - 4.2 = 41.8 \text{ MPa}$$

Since the shear stress acts at right angles to the tensile and compressive stresses, therefore maximum principal stress (tensile) on the section $Y-Y$ at the inner corner

$$\begin{aligned} &= \frac{\sigma_t}{2} + \frac{1}{2} \left[\sqrt{(\sigma_t)^2 + 4 \tau^2} \right] = \frac{50.2}{2} + \frac{1}{2} \left[\sqrt{(50.2)^2 + 4 \times (4.2)^2} \right] \text{ MPa} \\ &= 25.1 + 25.4 = 50.5 \text{ MPa Ans.} \end{aligned}$$

and maximum principal stress (compressive) on section $Y-Y$ at outer corner

$$\begin{aligned} &= \frac{\sigma_c}{2} + \frac{1}{2} \left[\sqrt{(\sigma_c)^2 + 4 \tau^2} \right] = \frac{41.8}{2} + \frac{1}{2} \left[\sqrt{(41.8)^2 + 4 \times (4.2)^2} \right] \text{ MPa} \\ &= 20.9 + 21.3 = 42.2 \text{ MPa Ans.} \end{aligned}$$

$$\text{Maximum shear stress} = \frac{1}{2} \left[\sqrt{(\sigma_t)^2 + 4 \tau^2} \right] = \frac{1}{2} \left[\sqrt{(50.2)^2 + 4 \times (4.2)^2} \right] = 25.4 \text{ MPa Ans.}$$

Stresses at section $Z-Z$

We know that bending moment at section $Z-Z$,

$$= 25 \times 10^3 \times 40 = 1 \times 10^6 \text{ N-mm}$$

and section modulus,
$$Z = \frac{t \cdot b^2}{6} = \frac{38.5 (77)^2}{6} = 38 \times 10^3 \text{ mm}^3$$

∴ Bending stress at section $Z-Z$,

$$\sigma_b = \frac{M}{Z} = \frac{1 \times 10^6}{38 \times 10^3} = 26.3 \text{ N/mm}^2 = 26.3 \text{ MPa Ans.}$$

The bending stress is tensile at the inner edge and compressive at the outer edge. The magnitude of both these stresses is 26.3 MPa. At the neutral axis, there is only transverse shear stress. The shear stress at the inner and outer edges will be zero.

We know that *maximum transverse shear stress,

$$\begin{aligned} \tau_{max} &= 1.5 \times \text{Average shear stress} = 1.5 \times \frac{P}{b \cdot t} = 1.5 \times \frac{25 \times 10^3}{77 \times 38.5} \\ &= 12.65 \text{ N/mm}^2 = 12.65 \text{ MPa Ans.} \end{aligned}$$

* Refer Art. 5.16

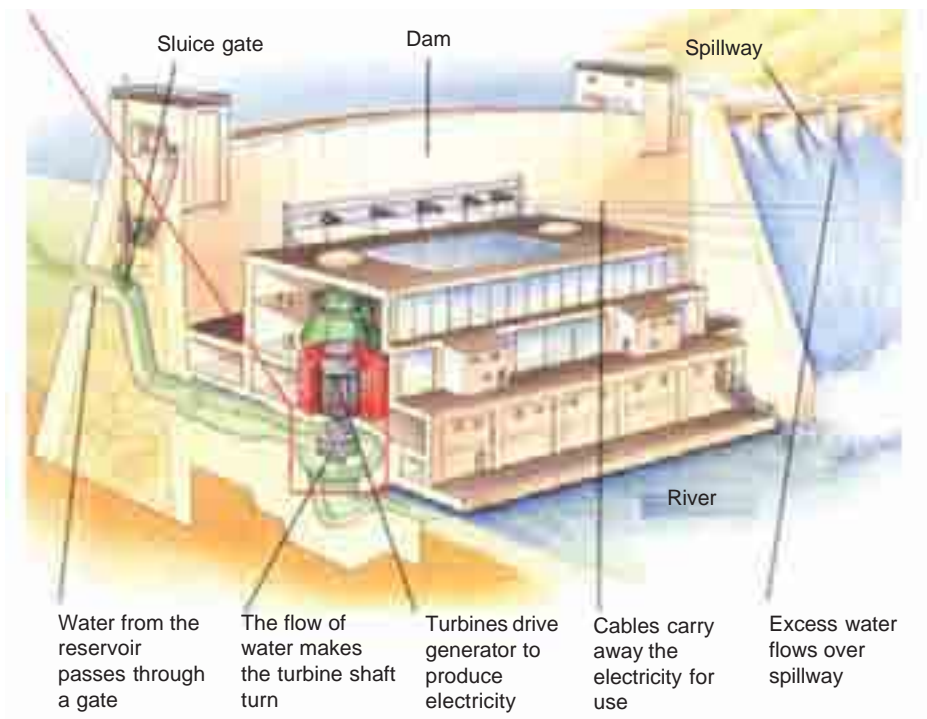

General layout of a hydroelectric plant.

Note : This picture is given as additional information and is not a direct example of the current chapter.

5.16 Shear Stresses in Beams

In the previous article, we have assumed that no shear force is acting on the section. But, in actual practice, when a beam is loaded, the shear force at a section always comes into play along with the bending moment. It has been observed that the effect of the shear stress, as compared to the bending stress, is quite negligible and is of not much importance. But, sometimes, the shear stress at a section is of much importance in the design. It may be noted that the shear stress in a beam is not uniformly distributed over the cross-section but varies from zero at the outer fibres to a maximum at the neutral surface as shown in Fig. 5.30 and Fig. 5.31.

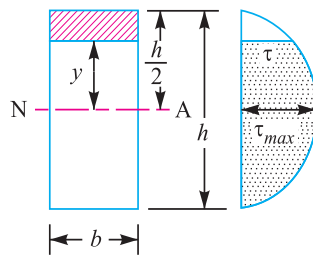

Fig. 5.30. Shear stress in a rectangular beam.

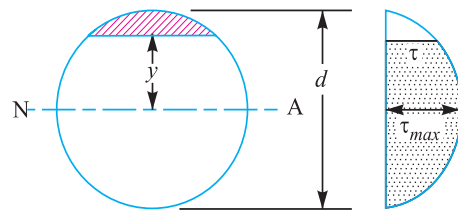

Fig. 5.31. Shear stress in a circular beam.

The shear stress at any section acts in a plane at right angle to the plane of the bending stress and its value is given by

$$\tau = \frac{F}{I \cdot b} \times A \cdot \bar{y}$$

where

- F = Vertical shear force acting on the section,
- I = Moment of inertia of the section about the neutral axis,
- b = Width of the section under consideration,
- A = Area of the beam above neutral axis, and
- \bar{y} = Distance between the C.G. of the area and the neutral axis.

The following values of maximum shear stress for different cross-section of beams may be noted :

1. For a beam of rectangular section, as shown in Fig. 5.30, the shear stress at a distance y from neutral axis is given by

$$\tau = \frac{F}{2I} \left(\frac{h^2}{4} - y^2 \right) = \frac{3F}{2b \cdot h^3} (h^2 - 4y^2) \quad \dots \left[\because I = \frac{b \cdot h^3}{12} \right]$$

and maximum shear stress,

$$\begin{aligned} \tau_{max} &= \frac{3F}{2b \cdot h} && \dots \left(\text{Substituting } y = \frac{h}{2} \right) \\ &= 1.5 \tau_{(average)} && \dots \left[\because \tau_{(average)} = \frac{F}{\text{Area}} = \frac{F}{b \cdot h} \right] \end{aligned}$$

The distribution of stress is shown in Fig. 5.30.

2. For a beam of circular section as shown in Fig. 5.31, the shear stress at a distance y from neutral axis is given by

$$\tau = \frac{F}{3I} \left(\frac{d^2}{4} - y^2 \right) = \frac{16 F}{3 \pi d^4} (d^2 - 4y^2)$$

and the maximum shear stress,

$$\begin{aligned} \tau_{max} &= \frac{4F}{3 \times \frac{\pi}{4} d^2} && \dots \left(\text{Substituting } y = \frac{d}{2} \right) \\ &= \frac{4}{3} \tau_{(average)} && \dots \left[\because \tau_{(average)} = \frac{F}{\text{Area}} = \frac{F}{\frac{\pi}{4} d^2} \right] \end{aligned}$$

The distribution of stress is shown in Fig. 5.31.

3. For a beam of I-section as shown in Fig. 5.32, the maximum shear stress occurs at the neutral axis and is given by

$$\tau_{max} = \frac{F}{I \cdot b} \left[\frac{B}{8} (H^2 - h^2) + \frac{b \cdot h^2}{8} \right]$$

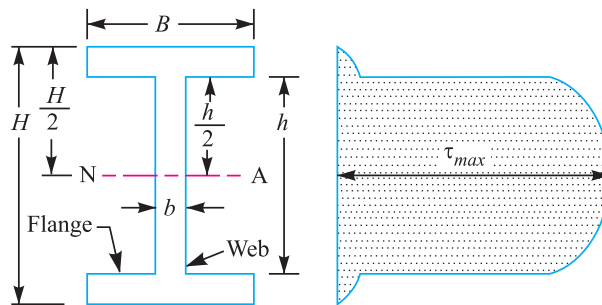

Fig. 5.32

Shear stress at the joint of the web and the flange

$$= \frac{F}{8I} (H^2 - h^2)$$

and shear stress at the junction of the top of the web and bottom of the flange

$$= \frac{F}{8I} \times \frac{B}{b} (H^2 - h^2)$$

The distribution of stress is shown in Fig. 5.32.

Example 5.27. A beam of I-section 500 mm deep and 200 mm wide has flanges 25 mm thick and web 15 mm thick, as shown in Fig. 5.33 (a). It carries a shearing force of 400 kN. Find the maximum intensity of shear stress in the section, assuming the moment of inertia to be $645 \times 10^6 \text{ mm}^4$. Also find the shear stress at the joint and at the junction of the top of the web and bottom of the flange.

Solution. Given : $H = 500 \text{ mm}$; $B = 200 \text{ mm}$; $h = 500 - 2 \times 25 = 450 \text{ mm}$; $b = 15 \text{ mm}$; $F = 400 \text{ kN} = 400 \times 10^3 \text{ N}$; $I = 645 \times 10^6 \text{ mm}^4$

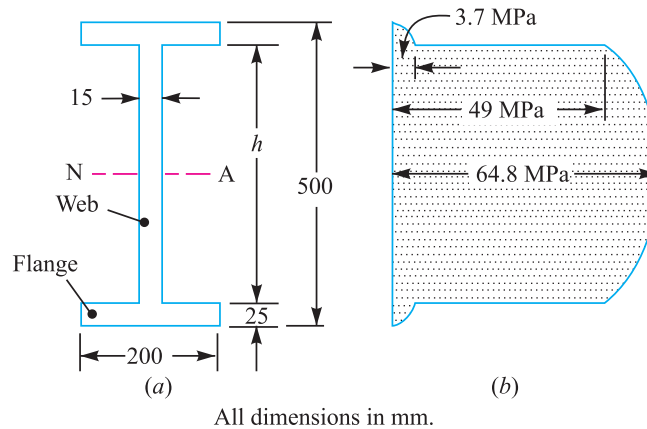

Fig. 5.33

Maximum intensity of shear stress

We know that maximum intensity of shear stress,

$$\begin{aligned} \tau_{max} &= \frac{F}{I \cdot b} \left[\frac{B}{8} (H^2 - h^2) + \frac{b \cdot h^2}{8} \right] \\ &= \frac{400 \times 10^3}{645 \times 10^6 \times 15} \left[\frac{200}{8} (500^2 - 450^2) + \frac{15 \times 450^2}{8} \right] \text{ N/mm}^2 \\ &= 64.8 \text{ N/mm}^2 = 64.8 \text{ MPa} \text{ Ans.} \end{aligned}$$

The maximum intensity of shear stress occurs at neutral axis.

Note : The maximum shear stress may also be obtained by using the following relation :

$$\tau_{max} = \frac{F \cdot A \cdot \bar{y}}{I \cdot b}$$

We know that area of the section above neutral axis,

$$A = 200 \times 25 + \frac{450}{2} \times 15 = 8375 \text{ mm}^2$$

Distance between the centre of gravity of the area and neutral axis,

$$\bar{y} = \frac{200 \times 25 (225 + 12.5) + 225 \times 15 \times 112.5}{8375} = 187 \text{ mm}$$

$$\therefore \tau_{max} = \frac{400 \times 10^3 \times 8375 \times 187}{645 \times 10^6 \times 15} = 64.8 \text{ N/mm}^2 = 64.8 \text{ MPa Ans.}$$

Shear stress at the joint of the web and the flange

We know that shear stress at the joint of the web and the flange

$$\begin{aligned} &= \frac{F}{8I} (H^2 - h^2) = \frac{400 \times 10^3}{8 \times 645 \times 10^6} [(500)^2 - (450)^2] \text{ N/mm}^2 \\ &= 3.7 \text{ N/mm}^2 = 3.7 \text{ MPa Ans.} \end{aligned}$$

Shear stress at the junction of the top of the web and bottom of the flange

We know that shear stress at junction of the top of the web and bottom of the flange

$$\begin{aligned} &= \frac{F}{8I} \times \frac{B}{b} (H^2 - h^2) = \frac{400 \times 10^3}{8 \times 645 \times 10^6} \times \frac{200}{15} [(500)^2 - (450)^2] \text{ N/mm}^2 \\ &= 49 \text{ N/mm}^2 = 49 \text{ MPa Ans.} \end{aligned}$$

The stress distribution is shown in Fig. 5.33 (b)

EXERCISES

1. A steel shaft 50 mm diameter and 500 mm long is subjected to a twisting moment of 1100 N-m, the total angle of twist being 0.6°. Find the maximum shearing stress developed in the shaft and modulus of rigidity. **[Ans. 44.8 MPa; 85.6 kN/m²]**
2. A shaft is transmitting 100 kW at 180 r.p.m. If the allowable stress in the material is 60 MPa, find the suitable diameter for the shaft. The shaft is not to twist more than 1° in a length of 3 metres. Take $C = 80 \text{ GPa}$. **[Ans. 105 mm]**
3. Design a suitable diameter for a circular shaft required to transmit 90 kW at 180 r.p.m. The shear stress in the shaft is not to exceed 70 MPa and the maximum torque exceeds the mean by 40%. Also find the angle of twist in a length of 2 metres. Take $C = 90 \text{ GPa}$. **[Ans. 80 mm; 2.116°]**
4. Design a hollow shaft required to transmit 11.2 MW at a speed of 300 r.p.m. The maximum shear stress allowed in the shaft is 80 MPa and the ratio of the inner diameter to outer diameter is 3/4. **[Ans. 240 mm; 320 mm]**
5. Compare the weights of equal lengths of hollow shaft and solid shaft to transmit a given torque for the same maximum shear stress. The material for both the shafts is same and inside diameter is 2/3 of outside diameter in case of hollow shaft. **[Ans. 0.56]**
6. A spindle as shown in Fig. 5.34, is a part of an industrial brake and is loaded as shown. Each load P is equal to 4 kN and is applied at the mid point of its bearing. Find the diameter of the spindle, if the maximum bending stress is 120 MPa. **[Ans. 22 mm]**

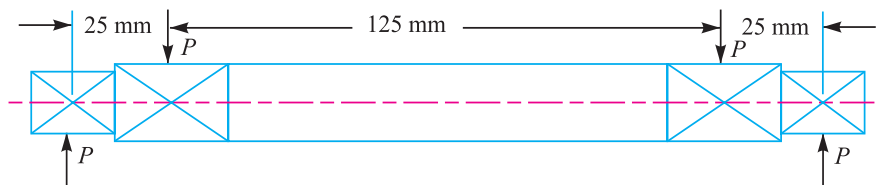
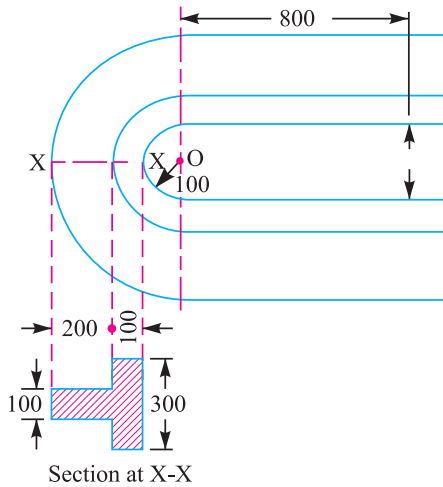

Fig. 5.34

7. A cast iron pulley transmits 20 kW at 300 r.p.m. The diameter of the pulley is 550 mm and has four straight arms of elliptical cross-section in which the major axis is twice the minor axis. Find the dimensions of the arm, if the allowable bending stress is 15 MPa. **[Ans. 60 mm; 30 mm]**

8. A shaft is supported in bearings, the distance between their centres being 1 metre. It carries a pulley in the centre and it weighs 1 kN. Find the diameter of the shaft, if the permissible bending stress for the shaft material is 40 MPa. **[Ans. 40 mm]**
9. A punch press, used for stamping sheet metal, has a punching capacity of 50 kN. The section of the frame is as shown in Fig. 5.35. Find the resultant stress at the inner and outer fibre of the section. **[Ans. 28.3 MPa (tensile); 17.7 MPa (compressive)]**



All dimensions in mm.

Fig. 5.35

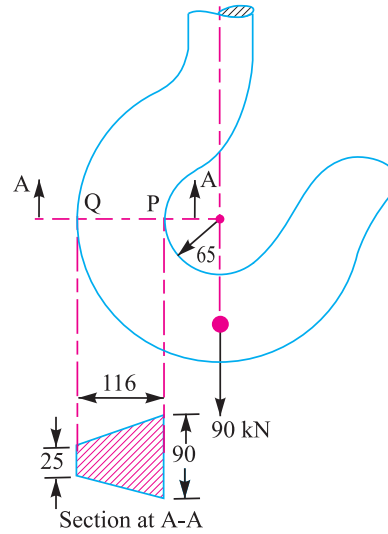

All dimensions in mm.

Fig. 5.36

10. A crane hook has a trapezoidal section at A-A as shown in Fig. 5.36. Find the maximum stress at points P and Q. **[Ans. 118 MPa (tensile); 62 MPa (compressive)]**
11. A rotating shaft of 16 mm diameter is made of plain carbon steel. It is subjected to axial load of 5000 N, a steady torque of 50 N-m and maximum bending moment of 75 N-m. Calculate the factor of safety available based on 1. Maximum normal stress theory; and 2. Maximum shear stress theory. Assume yield strength as 400 MPa for plain carbon steel. If all other data remaining same, what maximum yield strength of shaft material would be necessary using factor of safety of 1.686 and maximum distortion energy theory of failure. Comment on the result you get. **[Ans. 1.752; 400 MPa]**
12. A hand cranking lever, as shown in Fig. 5.37, is used to start a truck engine by applying a force $F = 400$ N. The material of the cranking lever is 30C8 for which yield strength = 320 MPa; Ultimate tensile strength = 500 MPa; Young's modulus = 205 GPa; Modulus of rigidity = 84 GPa and poisson's ratio = 0.3.

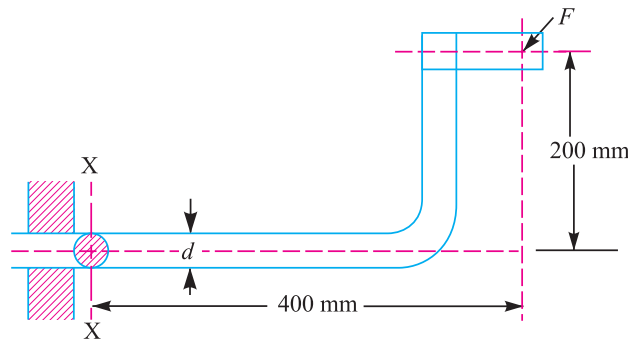
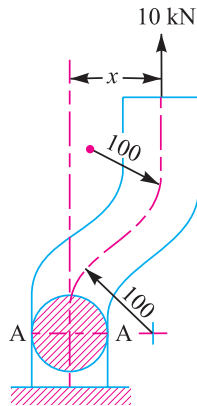

Fig. 5.37

Assuming factor of safety to be 4 based on yield strength, design the diameter 'd' of the lever at section X-X near the guide bush using : 1. Maximum distortion energy theory; and 2. Maximum shear stress theory. [Ans. 28.2 mm; 28.34 mm]

13. An offset bar is loaded as shown in Fig. 5.38. The weight of the bar may be neglected. Find the maximum offset (*i.e.*, the dimension x) if allowable stress in tension is limited to 70 MPa. [Ans. 418 mm]



All dimensions in mm.

Fig. 5.38

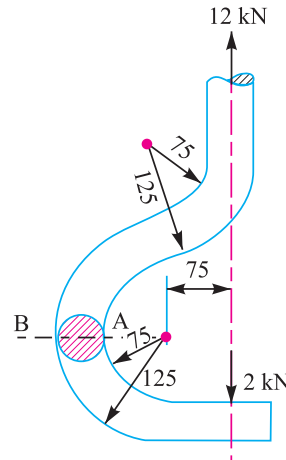

All dimensions in mm.

Fig. 5.39

14. A crane hook made from a 50 mm diameter bar is shown in Fig. 5.39. Find the maximum tensile stress and specify its location. [Ans. 35.72 MPa at A]
15. An overhang crank, as shown in Fig. 5.40 carries a tangential load of 10 kN at the centre of the crankpin. Find the maximum principal stress and the maximum shear stress at the centre of the crank-shaft bearing. [Ans. 29.45 MPa; 18.6 MPa]

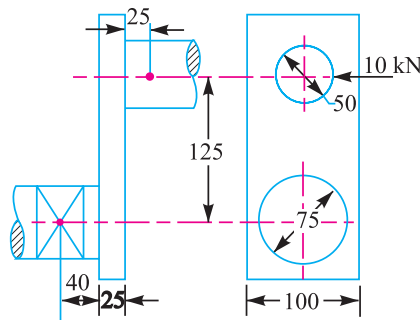

All dimensions in mm.

Fig. 5.40

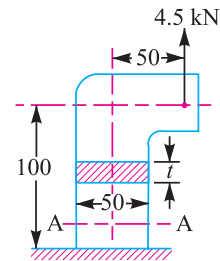

All dimensions in mm.

Fig. 5.41

16. A steel bracket is subjected to a load of 4.5 kN, as shown in Fig. 5.41. Determine the required thickness of the section at A-A in order to limit the tensile stress to 70 MPa. [Ans. 9 mm]

178 ■ A Textbook of Machine Design

17. A wall bracket, as shown in Fig. 5.42, is subjected to a pull of $P = 5 \text{ kN}$, at 60° to the vertical. The cross-section of bracket is rectangular having $b = 3t$. Determine the dimensions b and t if the stress in the material of the bracket is limited to 28 MPa . [Ans. 75 mm; 25 mm]

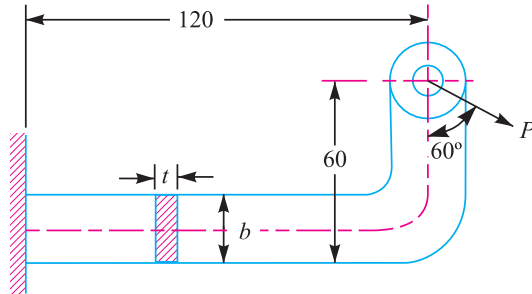

All dimensions in mm.

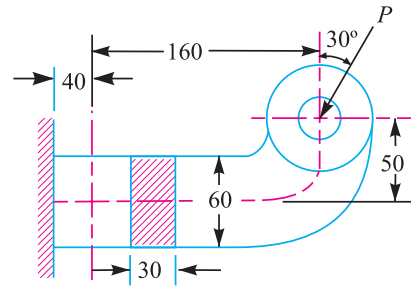

All dimensions in mm.

Fig. 5.42

Fig. 5.43

18. A bracket, as shown in Fig. 5.43, is bolted to the framework of a machine which carries a load P . The cross-section at 40 mm from the fixed end is rectangular with dimensions, $60 \text{ mm} \times 30 \text{ mm}$. If the maximum stress is limited to 70 MPa , find the value of P .

[Ans. 3000 N]

19. A T-section of a beam, as shown in Fig. 5.44, is subjected to a vertical shear force of 100 kN . Calculate the shear stress at the neutral axis and at the junction of the web and the flange. The moment of inertia at the neutral axis is $113.4 \times 10^6 \text{ mm}^4$.

[Ans. 11.64 MPa; 11 MPa; 2.76 MPa]

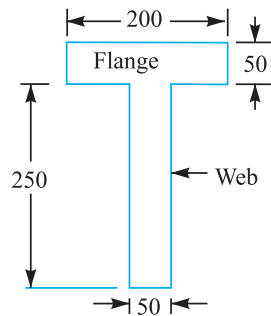

All dimensions in mm.

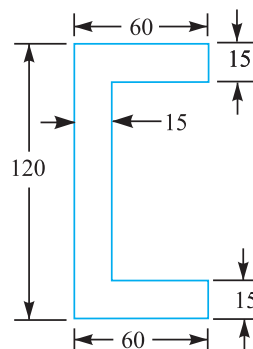

All dimensions in mm.

Fig. 5.44

Fig. 5.45

20. A beam of channel section, as shown in Fig. 5.45, is subjected to a vertical shear force of 50 kN . Find the ratio of maximum and mean shear stresses. Also draw the distribution of shear stresses.

[Ans. 2.22]

QUESTIONS

1. Derive a relation for the shear stress developed in a shaft, when it is subjected to torsion.
2. State the assumptions made in deriving a bending formula.

3. Prove the relation: $M/I = \sigma/y = E/R$
 where M = Bending moment; I = Moment of inertia; σ = Bending stress in a fibre at a distance y from the neutral axis; E = Young's modulus; and R = Radius of curvature.
4. Write the relations used for maximum stress when a machine member is subjected to tensile or compressive stresses along with shearing stresses.
5. Write short note on maximum shear stress theory *verses* maximum strain energy theory.
6. Distinguish clearly between direct stress and bending stress.
7. What is meant by eccentric loading and eccentricity?
8. Obtain a relation for the maximum and minimum stresses at the base of a symmetrical column, when it is subjected to
 (a) an eccentric load about one axis, and (b) an eccentric load about two axes.

OBJECTIVE TYPE QUESTIONS

1. When a machine member is subjected to torsion, the torsional shear stress set up in the member is
 (a) zero at both the centroidal axis and outer surface of the member
 (b) Maximum at both the centroidal axis and outer surface of the member
 (c) zero at the centroidal axis and maximum at the outer surface of the member
 (d) none of the above
2. The torsional shear stress on any cross-section normal to the axis is the distance from the centre of the axis.
 (a) directly proportional (b) inversely proportional to
3. The neutral axis of a beam is subjected to
 (a) zero stress (b) maximum tensile stress
 (c) maximum compressive stress (d) maximum shear stress
4. At the neutral axis of a beam,
 (a) the layers are subjected to maximum bending stress
 (b) the layers are subjected to tension (c) the layers are subjected to compression
 (d) the layers do not undergo any strain
5. The bending stress in a curved beam is
 (a) zero at the centroidal axis (b) zero at the point other than centroidal axis
 (c) maximum at the neutral axis (d) none of the above
6. The maximum bending stress, in a curved beam having symmetrical section, always occur, at the
 (a) centroidal axis (b) neutral axis
 (c) inside fibre (d) outside fibre
7. If d = diameter of solid shaft and τ = permissible stress in shear for the shaft material, then torsional strength of shaft is written as
 (a) $\frac{\pi}{32} d^4 \tau$ (b) $d \log_e \tau$
 (c) $\frac{\pi}{16} d^3 \tau$ (d) $\frac{\pi}{32} d^3 \tau$
8. If d_i and d_o are the inner and outer diameters of a hollow shaft, then its polar moment of inertia is
 (a) $\frac{\pi}{32} [(d_o)^4 - (d_i)^4]$ (b) $\frac{\pi}{32} [(d_o)^3 - (d_i)^3]$
 (c) $\frac{\pi}{32} [(d_o)^2 - (d_i)^2]$ (d) $\frac{\pi}{32} (d_o - d_i)$

180 ■ A Textbook of Machine Design

9. Two shafts under pure torsion are of identical length and identical weight and are made of same material. The shaft *A* is solid and the shaft *B* is hollow. We can say that
- shaft *B* is better than shaft *A*
 - shaft *A* is better than shaft *B*
 - both the shafts are equally good
10. A solid shaft transmits a torque *T*. The allowable shear stress is τ . The diameter of the shaft is
- $\sqrt[3]{\frac{16 T}{\pi \tau}}$
 - $\sqrt[3]{\frac{32 T}{\pi \tau}}$
 - $\sqrt[3]{\frac{64 T}{\pi \tau}}$
 - $\sqrt[3]{\frac{16 T}{\tau}}$
11. When a machine member is subjected to a tensile stress (σ_t) due to direct load or bending and a shear stress (τ) due to torsion, then the maximum shear stress induced in the member will be
- $\frac{1}{2} \left[\sqrt{(\sigma_t)^2 + 4 \tau^2} \right]$
 - $\frac{1}{2} \left[\sqrt{(\sigma_t)^2 - 4 \tau^2} \right]$
 - $\left[\sqrt{(\sigma_t)^2 + 4 \tau^2} \right]$
 - $(\sigma_t)^2 + 4 \tau^2$
12. Rankine's theory is used for
- brittle materials
 - ductile materials
 - elastic materials
 - plastic materials
13. Guest's theory is used for
- brittle materials
 - ductile materials
 - elastic materials
 - plastic materials
14. At the neutral axis of a beam, the shear stress is
- zero
 - maximum
 - minimum
15. The maximum shear stress developed in a beam of rectangular section is the average shear stress.
- equal to
 - $\frac{4}{3}$ times
 - 1.5 times

ANSWERS

- | | | | | |
|---------|---------|---------|---------|---------|
| 1. (b) | 2. (a) | 3. (a) | 4. (d) | 5. (b) |
| 6. (c) | 7. (c) | 8. (a) | 9. (a) | 10. (a) |
| 11. (a) | 12. (a) | 13. (b) | 14. (b) | 15. (c) |