



المحاضرة الثالثة

كيفية رسم رموز الميكانيكية في أنظمة التكييف و التبريد

المقدمة





تتكون منظومات التبريد والتكييف والتثليج من عناصر عديدة:

- الاجزاء الاساسية: مثل الضواغط , المبخرات , المكثفات , ادوات التمدد والمستلم وغيرها.
- الاجزاء الخدمية: مثل مستلم سائل, وسيط التبريد ومصيدة الزيت.
- الاجزاء التي تستخدم للسيطرة: مثل الموقتات الزمنية ومنظم درجات الحرارة وغيرها.

ولصعوبة رسوم معظم هذه الاجزاء بالتفصيل الدقيق, تم استعادة برموز بسيطة متفق عليها عالميا لتصبح لغة العاملين في مجال التبريد والتثليج. وهذه الرموز هي:

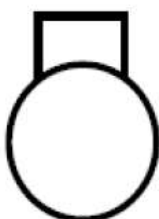
الميكانيكية الرموز

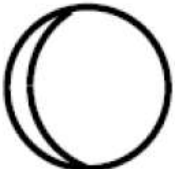
رموز الضاغطات:

الرمز	نموذج	العنصر
		الضاغط بصفة عامة Compressor , regular
		ضاغط دوراني ، علبه المرافق مغلقة، ادارة بسير Compressor, rotary, enclosed crankcase, belted



		مبخر مبرد بالهواء ، حمل حر Natural convection, Finned type Evaporator
		مبخر مبرد بالهواء ، مزعنف حمل قسري Forced convection Evaporator
		مبخر متشعب ، لوجي Plate coil Evaporator

رموز بعض عناصر التبريد:

الرمز	نموذج	العنصر
		وحدة تبريد بالتغطيس Immersion cooling unit











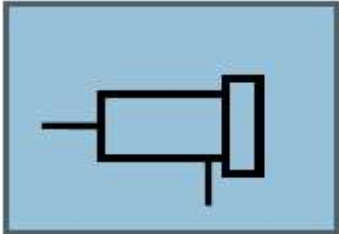

		برج تبريد Cooling tower
		مبادل حراري Heat exchanger
		زجاجة بيان Sight glass

رموز بعض المصائد:

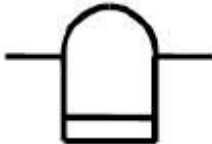
الرمز	نموذج	العنصر
		مجفف Drier
		مصفاة Strainer



		مجفف و مصفاة Strainer and drier
		مرشح و مصفاة Filter and strainer
		مرشح خطي Line Filter
		مصيدة قشور Scale trap
		مصيدة بكيس Basket trap



		رجوع إلى الغلاية Boiler return
		مصيدة بعوامة Float trap
		مصيدة بثرموستات و عوامة Traps, thermostatic

رموز الصمامات:

الرمز	نموذج	العنصر
		صمام بعوامة للجانب العالي High side float valve



		صمام بعوامة للجانب المنخفض low side float valve
		صمام بوابي gate valve
		صمام كروي Globe valve
		صمام محمي Lock shield valve
		جزرة إيقاف Plug













Class: 3rd Stage
Subject: Drawing of Air Conditioning
Asst.Lecturer: Hawraa Tayyeh
E-mail: Hawraa.tayyeh@mustaqbal-college.edu.iq

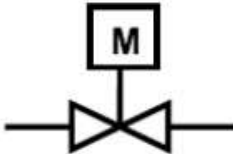

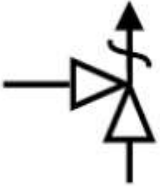

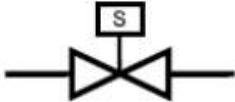







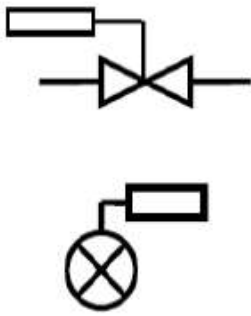

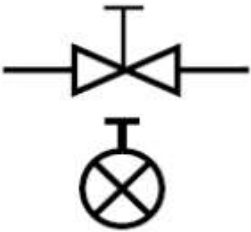
Class: 3rd Stage
Subject: Drawing of Air Conditioning
Asst.Lecturer: Hawraa Tayyeh
E-mail: Hawraa.tayyeh@mustaqbal-college.edu.iq

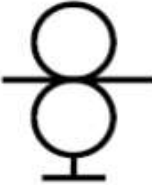
		صمام منظم للضغط Pressure regulating valve
		صمام مخفض للضغط Pressure-reducing valve
		صمام ، تحكم بمحرك Motor operated valve
		صمام تصريف Relief valve
		صمام مشغل بملف كهربائي Solenoid valve

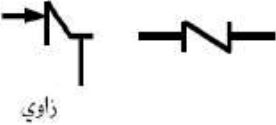

		<p>صمام تنظيم ضغط المبخر ، ثرموستاتي ، نوع خانق Valve, evaporator pressure regulating, Thermostatic throttling type</p>
		<p>صمام سحب الضاغط ، محدد للضغط ، نوع خانق (جانب الضاغط) Valve, compressor suction pressure limiting, Thermostatic throttling type(compressor side)</p>
		<p>صمام تنظيم ضغط المبخر ، ثرموستاتي ، فعل إطباق Valve, evaporator pressure regulating, Thermostatic snap action</p>
		<p>صمام سحب الضاغط ، محدد للضغط ، نوع خانق (جانب الضاغط) Valve, evaporator pressure regulating, throttling type(evaporator side)</p>

		<p style="text-align: center;">صمام تمدد ترموستاتي Thermostatic expansion valve</p>
		<p style="text-align: center;">صمام تمدد يدوي Hand expansion valve</p>
		<p style="text-align: center;">صمام ضغط ثابت Constant pressure valve</p>
 <p style="text-align: center;">زاوي</p>		<p style="text-align: center;">صمام عدم ارجاع Check valve</p>
		<p style="text-align: center;">صمام اتوماتيكي ذو اتجاهين 2-way automatic valve</p>



		صمام اتوماتيكي ذو ثلاثة اتجاهات 3-way automatic valve
		صمام خط هواء Air line valve
		مزيل هواء Air eliminator

رموز بعض اجهزة التحكم والقياس:

الرمز	نموذج	العنصر
		مفتاح ضغط Pressure switch
		مفتاح ضغط مزدوج Dual pressure switch











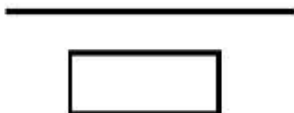

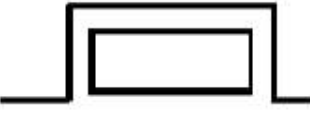
		جهاز قياس (ضغط او درجة الحرارة) gauges
		ثرموستات thermostat with remote bulb
		ثرموستات ذاتي الاحتواء Self-contained thermostat
		بصيلة حرارية Thermal bulb
		ثرموتر thermometer

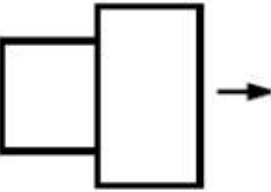

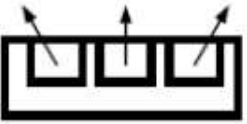

رموز بعض عناصر التكييف والتهوية:

العنصر	نموذج	الرمز
--------	-------	-------



		راديٲور عادية
		راديٲور
		وحدة تدفئة بأرياش Unit heater (propeller)
		وحدة تدفئة (مروحة طرد مركزي، مسقط رأسي) Unit heater (centrifugal)
		وحدة تهوية (مسقط رأسي) Unit ventilator

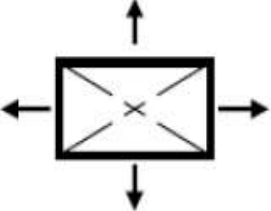

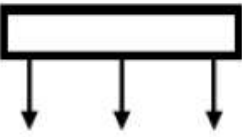
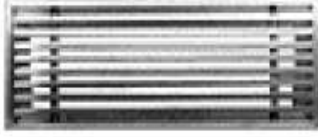
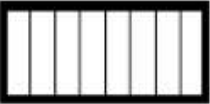
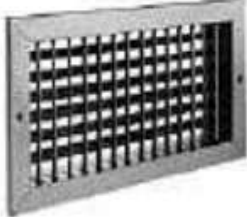
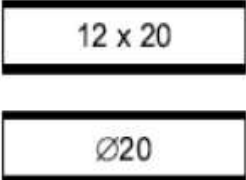
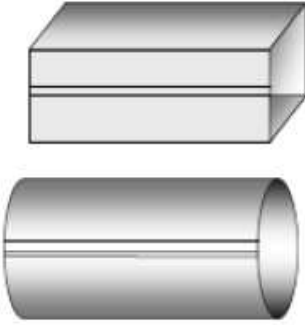
		ناشرة سقف دائرية Circular ceiling diffuser
		ناشرة سقف مربعة Square ceiling diffuser
		ناشرة مستقيمة Linear diffuser
		شبكة سطح Floor register
		المسلك (العرض x العمق او القطر) Duct





Class: 3rd Stage
Subject: Drawing of Air Conditioning
Asst.Lecturer: Hawraa Tayyeh
E-mail: Hawraa.tayyeh@mustaqbal-college.edu.iq





 		منظم خانق (تحكم يدوي) Manual volume damper
		منظم خانق (تحكم اوتوماتيكي) Automatic volume damper
		اتجاه الجريان او التدفق Direction of flow
		وصلة مرنة Flexible connection
		مسلك ذو ريش Turning duct section

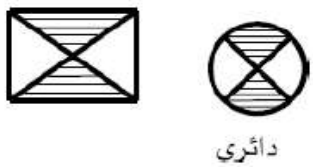
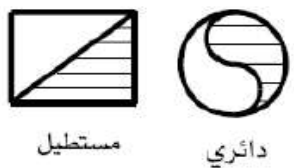
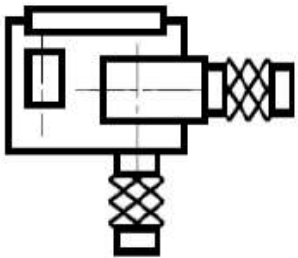
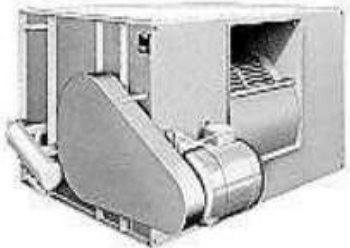

 <p>مقطع لمسلك امداد Supply duct section</p>		
 <p>مقطع لمسلك تصريف او اعادة تمرير Return, exhaust or out side duct section</p>		
  <p>مروحة ومحرك مع وقاء للسير Fan and motor with belt guard</p>		
  <p>مروحة ومحرك Fan and motor</p>		

رموز بعض العناصر الاخرى

الرمز	نموذج	العنصر
  <p>مستقبلة افقية Horizontal receiver</p>		



		مستقبلة رأسية Vertical receiver
		مركم / خزان تجميع accumulator
		مضخة pump
		فاصل زيت Oil separator