



# Refrigeration and Air conditioning Engineering.

3<sup>rd</sup> year – refrigeration and Air  
conditioning Course

Duct design

Lecture -10- PART2

M.Sc. Zahraa F. Hussain

# Duct Design Methods

Duct design methods for HVAC systems and for exhaust systems conveying vapors, gases, and smoke are the :

**1- equal friction method**

**2-the static regain method**

**3- T-method.**

The section on Industrial Exhaust System Duct Design presents the design criteria and procedures for exhaust systems conveying particulates.

**Equal friction and static regain** are non - optimizing methods, while the T-method is a practical optimization method. To ensure that system designs are acoustically acceptable, noise generation should be analyzed and sound attenuators and/or acoustically lined duct provided where necessary. Dampers must be installed throughout systems designed by equal friction, static regain, and the T-method because inaccuracies are introduced into these design methods by duct size round-off and the effect of close coupled fittings on the total pressure loss calculations.

# Equal Friction Method

In the equal friction method, ducts are sized for a constant pressure loss per unit length. The shaded area of the friction chart is the suggested range of friction rate and air velocity.

When energy cost is high and installed ductwork cost is low, a low friction rate design is more economical. For low energy cost and high duct cost, a higher friction rate is more economical.

After initial sizing, calculate the total pressure loss for all duct sections, and then resize sections to balance pressure losses at each junction.

The objective of the static regain method is to obtain the same static pressure at diverging flow junctions by changing downstream duct sizes.

# HVAC DUCT DESIGN PROCEDURES

## 1- Duct dimensions

The general procedure for HVAC system duct design is as follows:

- a) Study the building plans, and arrange the supply and return outlets to provide proper distribution of air within each space. Adjust calculated air quantities for duct heat gains or losses and duct leakage. Also, adjust the supply, return, and/or exhaust air quantities to meet space pressurization requirements.
- b) Select outlet sizes from manufacturers' data.
- c) Sketch the duct system, connecting supply outlets and return intakes with the air-handling units/air conditioners. Space allocated for supply and return ducts often dictates system layout and ductwork shape. Use round ducts whenever feasible.
- d) Divide the system into sections and number each section. A duct system should be divided at all points where flow, size, or shape changes. Assign fittings to the section toward the supply and return (or exhaust) terminals.
- e) Size ducts by the selected design method. Calculate system total pressure loss; then select the fan.
- f) Lay out the system in detail. If duct routing and fittings vary significantly from the original design, recalculate the pressure losses. Reselect the fan if necessary.
- g) Resize duct sections to approximately balance pressures at each junction.
- h) Analyze the design for objectionable noise levels, and specify sound attenuators as necessary. Refer to the section on System and Duct Noise.

## Example (2)

For the system illustrated by Figures belows, size the ductwork by the equal friction method. Determine the system resistance and total pressure unbalance at the junctions. The airflow quantities are actual values adjusted for heat gains or losses, and ductwork is sealed (assume no leakage), Air is at  $1.204 \text{ kg/m}^3$  density. The supply system is constructed of rectangular ductwork. the maximum main duct height is 0.25 m

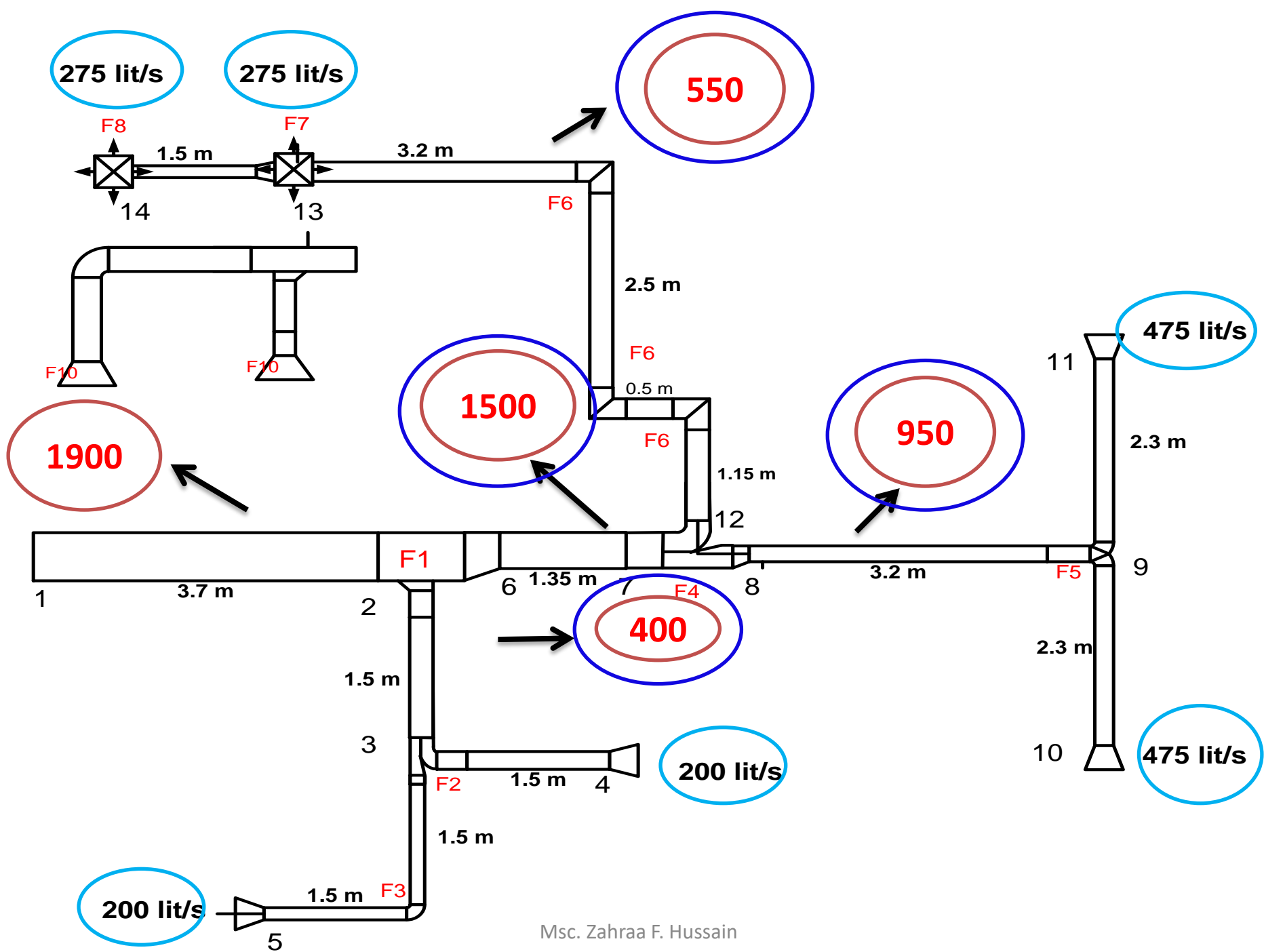

Table (2-1) Air velocity in duct system (m/s)

APPLICATION	CONTROLLING FACTOR NOISE GENERATION Main Duct	CONTROLLING FACTOR — DUCT FRICTION			
		Main Ducts		Branch Duct	
		Supply	Return	Supply	Return
Residences	3.0	5.1	3.0	3.0	3.0
Apartments Hotel Bedrooms Hospital Bedrooms	5.1	7.6	6.6	6.1	5.1
Private Offices Directors Rooms Libraries	6.1	10.2	7.6	7.1	6.1
Theatres Auditoriums	4.1	6.6	5.6	5.1	4.1
General Offices High Class Restaurants High Class Stores	7.6	10.2	7.6	8.1	6.1
Banks					
Average Stores Cafeterias	8.5	10.2	7.6	8.1	6.1
Industrial	12.7	15.2	9.1	11.2	7.6

**C=8.5**

- **Main duct section (1-2)**

- **V=C.A**

- **V=1.9 m<sup>3</sup>/s**

- **C=8.5 m/s (T2-1)**

- **1.9=8.5×A**

- **A=0.22335 m<sup>2</sup>**

- $A = \pi \frac{D^2}{4}$

- $0.22335 = \pi \frac{D^2}{4}$

- $D = \sqrt{\frac{4 \cdot A}{\pi}} = \sqrt{\frac{4 \cdot 0.22335}{3.14}} =$

- **D=0.533 m= 533mm**

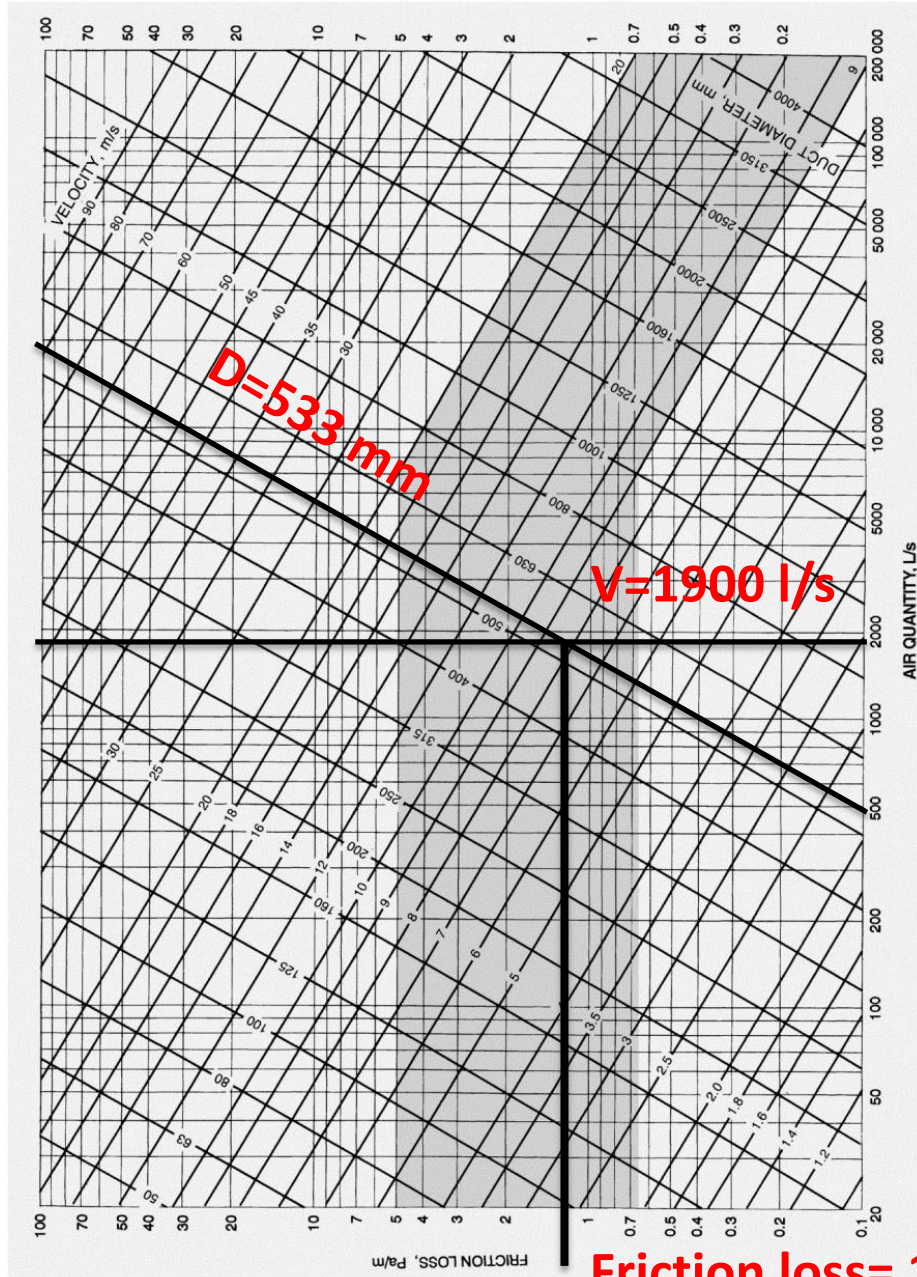
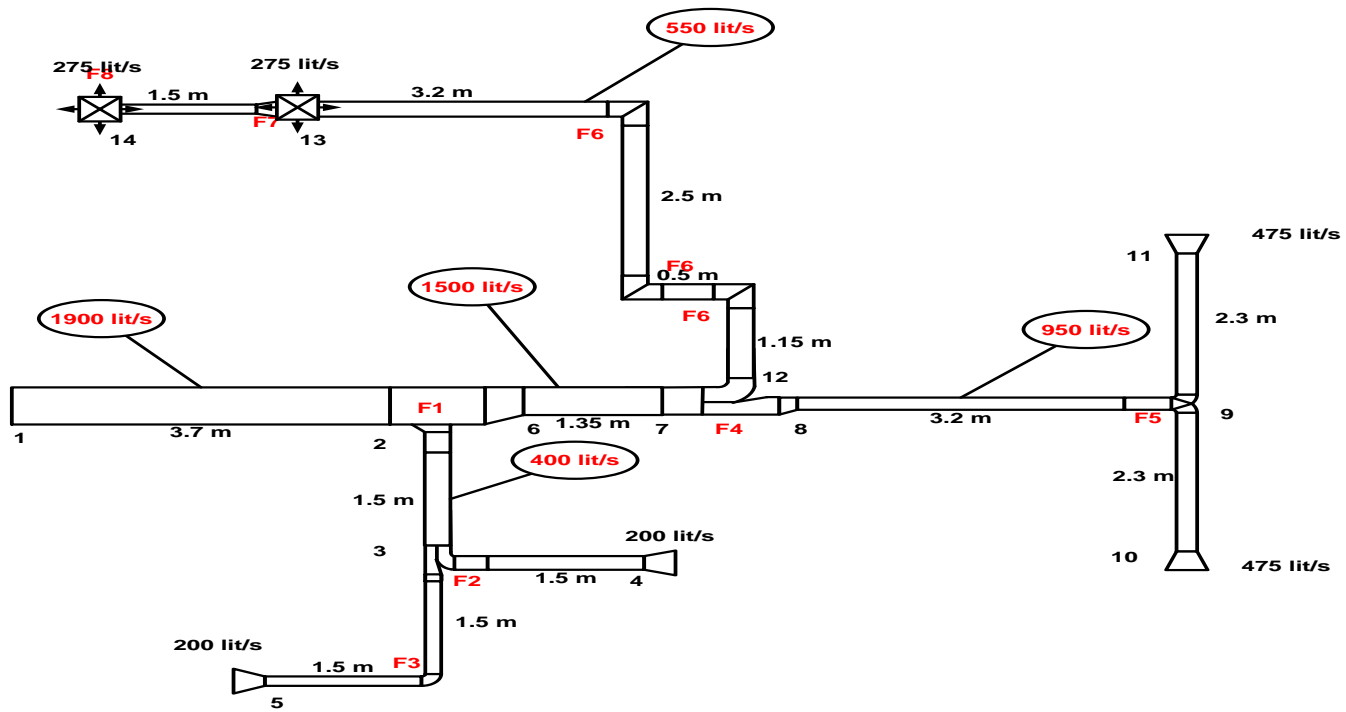

Fig.9 Friction Chart for Round Duct ( $\rho = 1.20 \text{ kg/m}^3$  and  $\epsilon = 0.09 \text{ mm}$ )

V=1900 l/s  
D=533 mm  
Friction line

Friction loss = 1.2 Pa./m





Section	V	Deq.	C	W	H	L
1-2	1900					
2-3	400					
3.4	200					
3-5	200					
6-7	1500					
8-9	950					
9-10	475					
9-11	475					
12-13	550					
13-14	275					

Section	V	Deq.	C
1-2	1900	533	8.5
2-3	400	280	5.5
3-4	200	230	4.5
3-5	200	230	4.5
6-7	1500	480	7.8
8-9	950	420	6.8
9-10	475	320	5.8
9-11	475	320	5.8
12-13	550	330	6
13-14	275	260	4.8

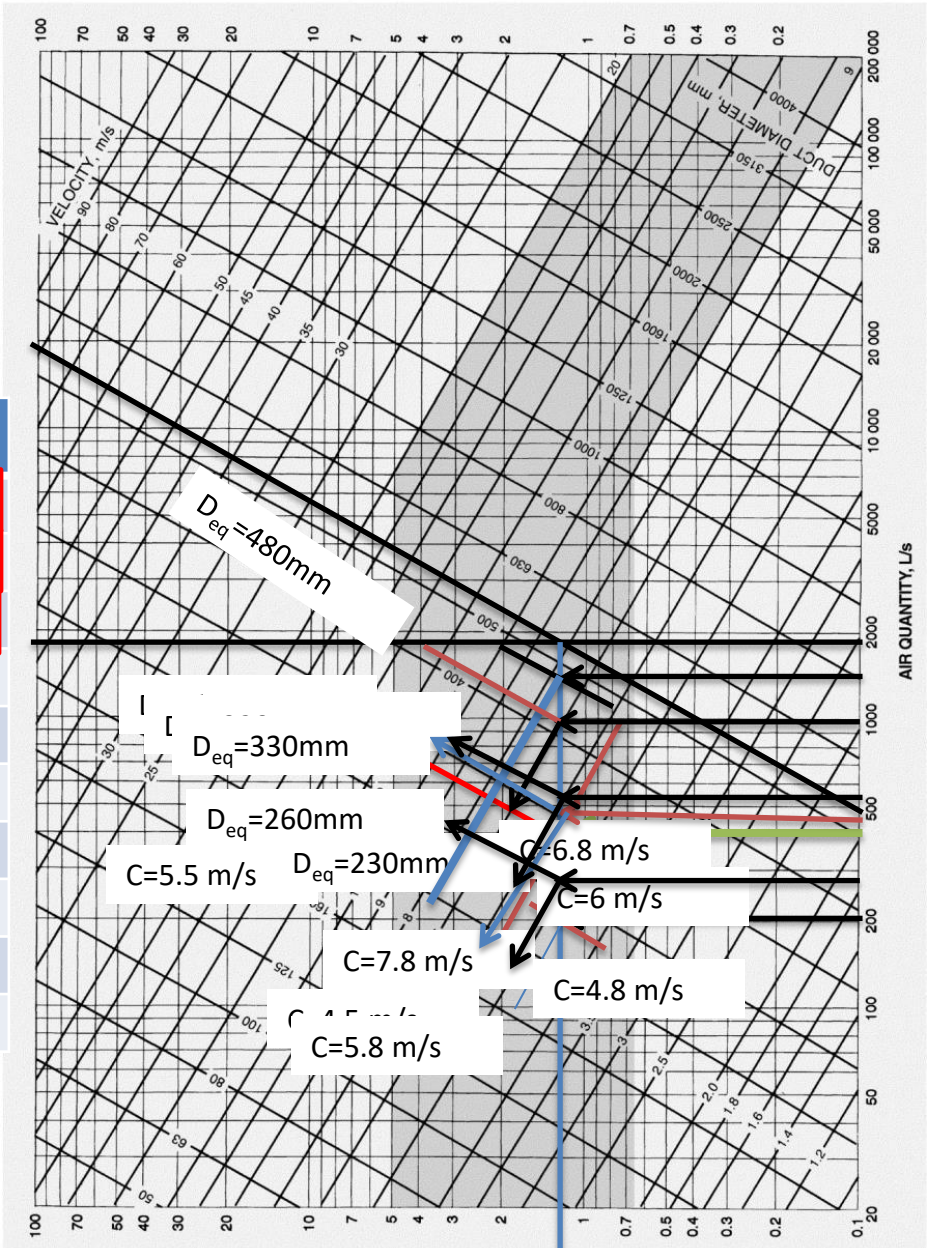
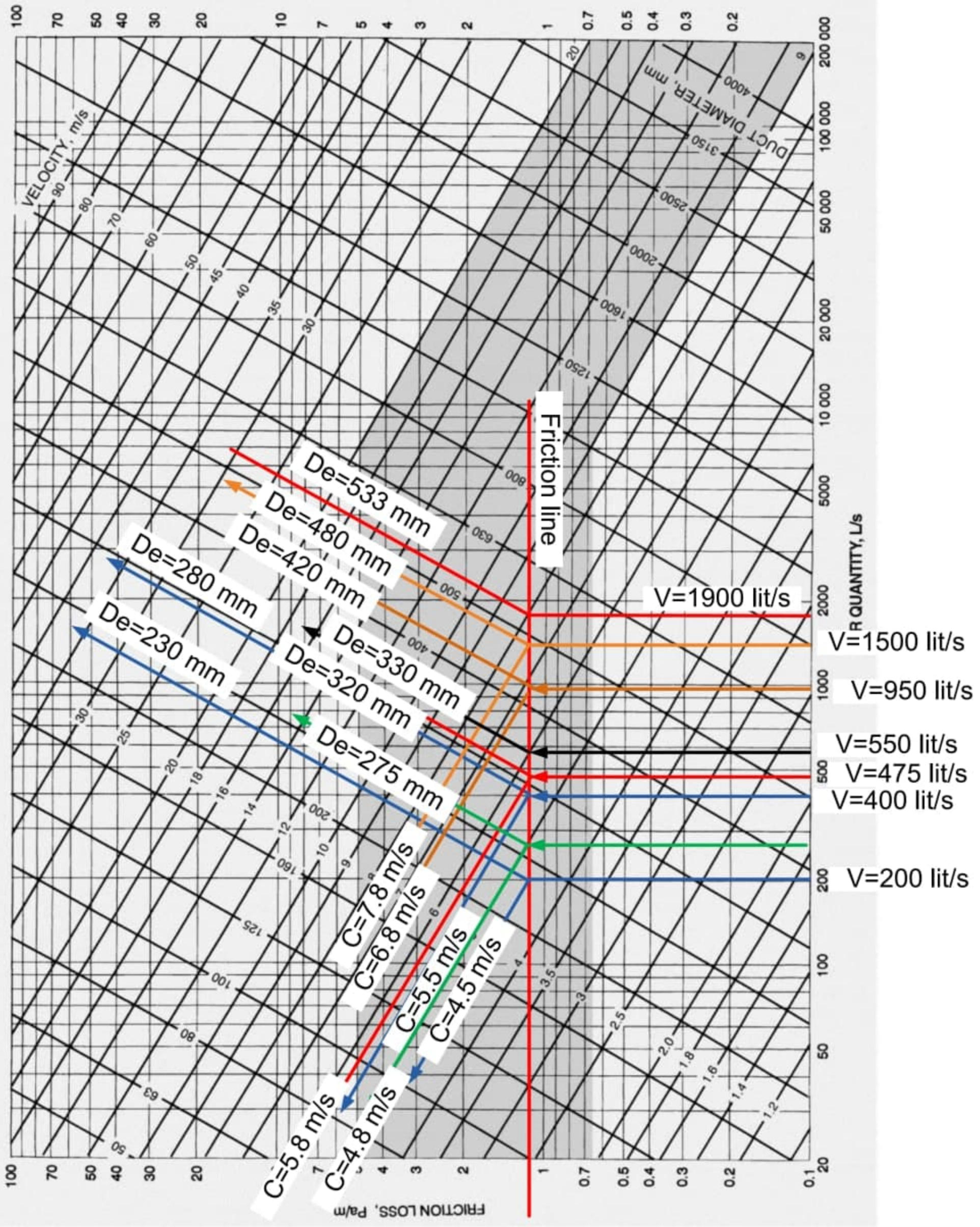

Fig.9 Friction Chart for Round Duct ( $\rho = 1.20\text{ kg/m}^3$  and  $\epsilon = 0.09\text{ mm}$ )

Friction loss= 1.2 Pa./m



De=533 mm  
De=480 mm  
De=420 mm

De=280 mm  
De=230 mm

De=330 mm  
De=320 mm  
De=275 mm

C=7.8 m/s  
C=6.8 m/s  
C=5.5 m/s  
C=4.5 m/s

V=1900 lit/s

V=1500 lit/s  
V=950 lit/s  
V=550 lit/s  
V=475 lit/s  
V=400 lit/s  
V=200 lit/s

Friction line



<b>Section</b>	<b>V (lit/s)</b>	<b>Deq. (mm)</b>	<b>C m/s</b>	<b>W (mm)</b>	<b>H (mm)</b>
<b>1-2</b>	<b>1900</b>	<b>533</b>	<b>8.5</b>	<b>1100</b>	<b>250</b>
<b>2-3</b>	<b>400</b>	<b>280</b>	<b>7</b>	<b>500</b>	<b>150</b>
<b>3-4</b>	<b>200</b>	<b>230</b>	<b>4.5</b>	<b>300</b>	<b>150</b>
<b>3-5</b>	<b>200</b>	<b>230</b>	<b>4.5</b>	<b>300</b>	<b>150</b>
<b>6-7</b>	<b>1500</b>	<b>480</b>	<b>7.8</b>	<b>900</b>	<b>250</b>
<b>8-9</b>	<b>950</b>	<b>420</b>	<b>6.8</b>	<b>650</b>	<b>250</b>
<b>9-10</b>	<b>475</b>	<b>320</b>	<b>5.8</b>	<b>650</b>	<b>150</b>
<b>9-11</b>	<b>475</b>	<b>320</b>	<b>5.8</b>	<b>650</b>	<b>150</b>
<b>12-13</b>	<b>550</b>	<b>330</b>	<b>6</b>	<b>700</b>	<b>150</b>
<b>13-14</b>	<b>275</b>	<b>260</b>	<b>4.8</b>	<b>400</b>	<b>150</b>

- Maximum length of the duct:
- **Path (1-2-6-7-12-13-14)=**  
 $=3.7+1.35+1.15+0.5+2.5+3.2+1.5=13.9\text{ m}$
- **Path(1-2-6-7-8-9-11)=**  
 $3.7+1.35+3.2+2.3=10.55\text{ m}$
- Then the **first path** must be selected.
- **Fittings** in path (1-2-6-7-12-13-14) are:
- **F1, F4, F6,F7 and F8.**
- The pressure loss in the fittings above should be calculated

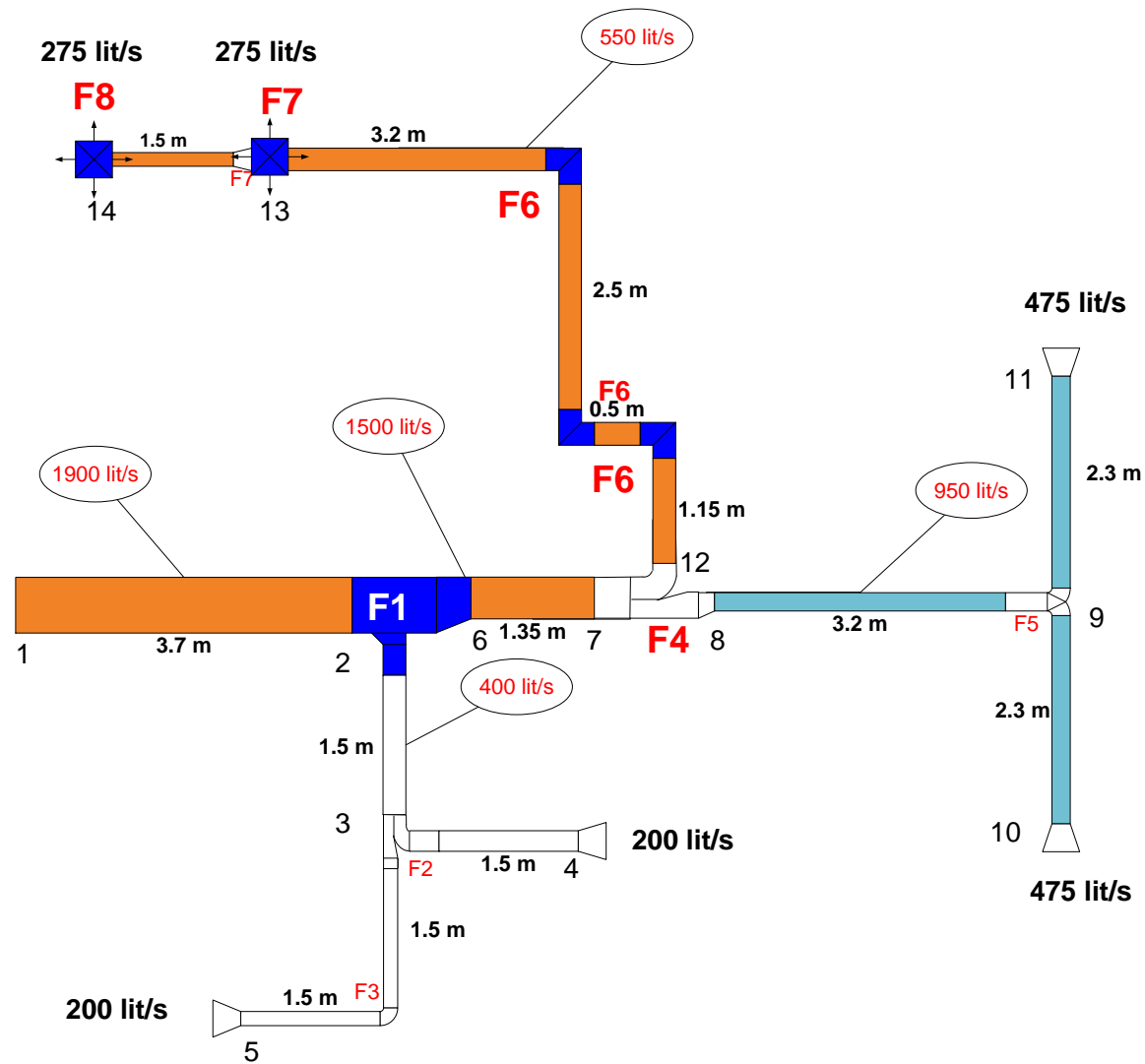

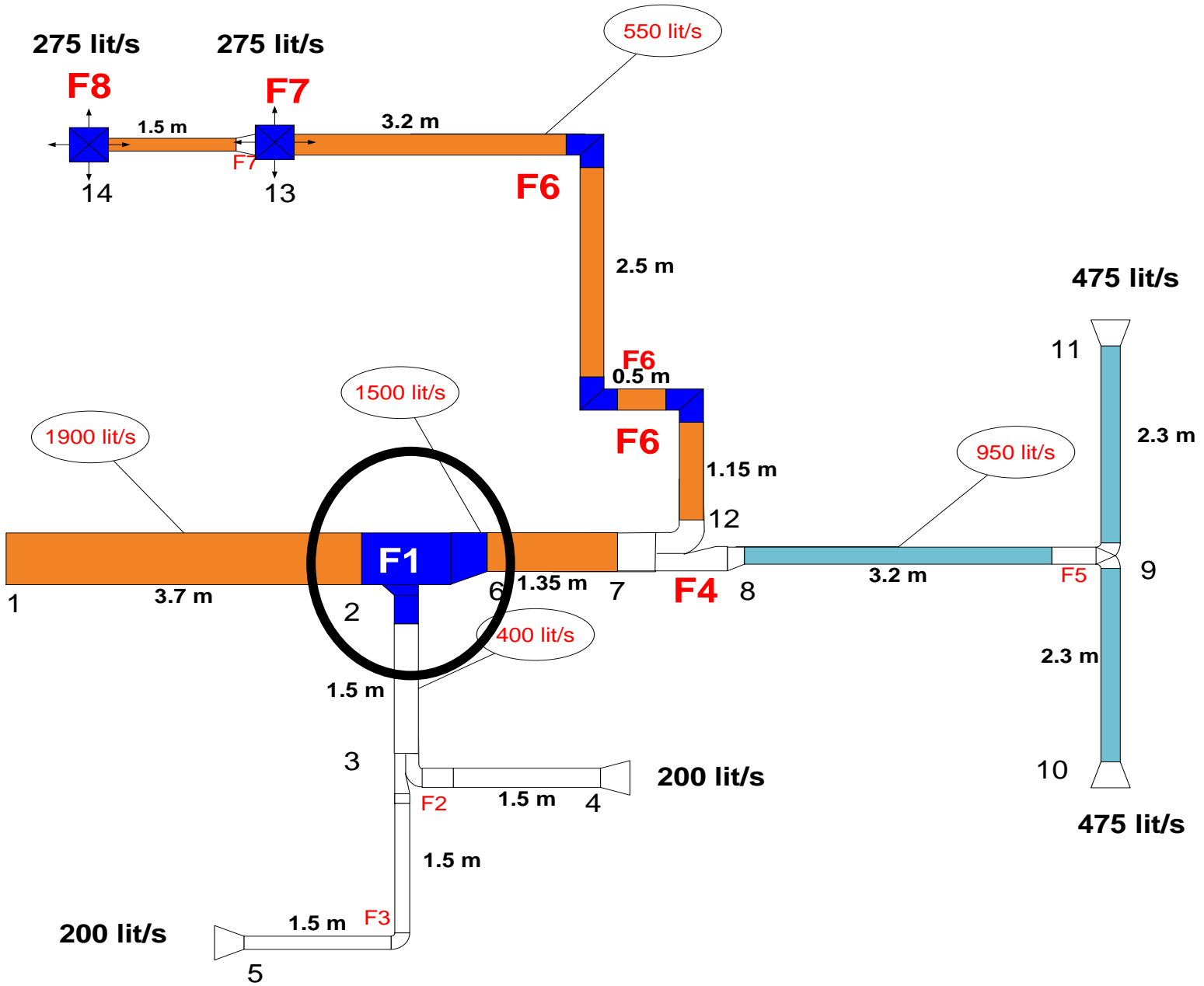

# Fitting F1

1.  $Q_c=1900$  lit/s
2.  $A_c=1.1 \times 0.25=0.275$  m<sup>2</sup>
3.  $Q_s=1500$  lit/s
4.  $A_s=0.25 \times 0.9=0.225$

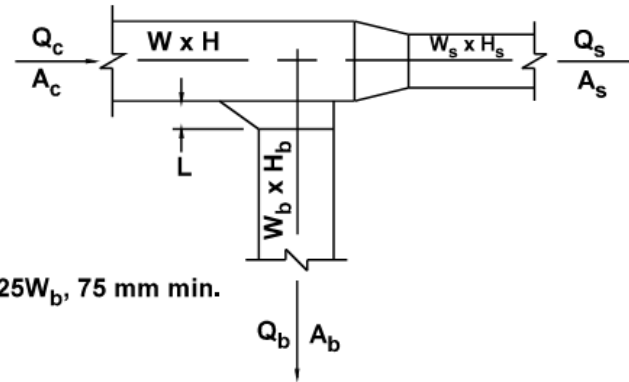
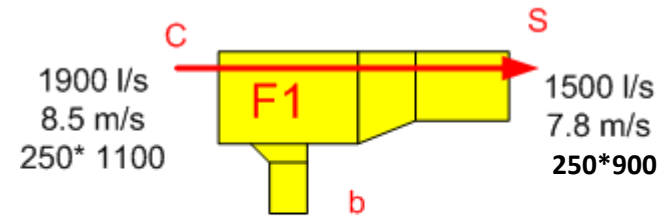

$L = 0.25W_b$ , 75 mm min.

$$1. \frac{A_s}{A_c} = \frac{0.225}{0.275} = 0.82$$

$$2. \frac{Q_s}{Q_c} = \frac{1500}{1900} = 0.789$$

$C_s$  Values

$A_s/A_c$	$Q_s/Q_c$								
	0.1	0.2	0.3	0.4	0.5	0.6	0.7	0.8	0.9
0.1	0.04								
0.2	0.98	0.04							
0.3	3.48	0.31	0.04						
0.4	7.55	0.98	0.18	0.04					
0.5	13.18	2.03	0.49	0.13	0.04				
0.6	20.38	3.48	0.98	0.31	0.10	0.04			
0.7	29.15	5.32	1.64	0.60	0.23	0.09	0.04		
0.8	39.48	7.55	2.47	0.98	0.42	0.18	0.08	0.04	
0.9	51.37	10.17	3.48	1.46	0.67	0.31	0.15	0.07	0.04

$C_s=0.07$

- $\Delta P = \frac{1}{2} \cdot C_s \rho \cdot C^2$

- $\Delta P(F1) =$

$$\frac{1}{2} \cdot 0.07 \times 1.204 \times 8.5^2 = 3.044$$



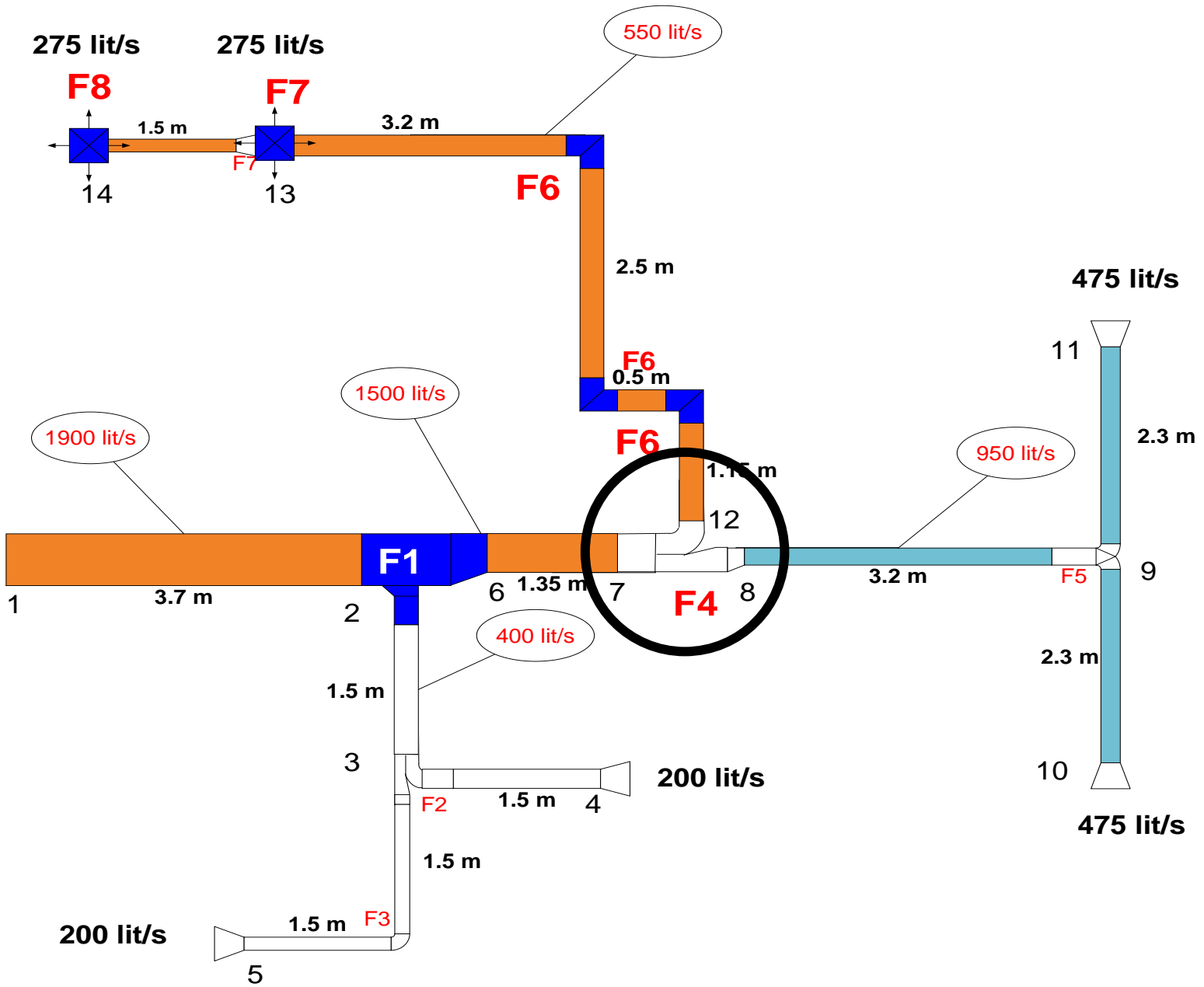

# Fitting F4

## SR5-1 Smooth Wye of Type $A_s + A_b \geq A_c$ , Branch 90° to Main, Diverging

1.  $Q_c = 1500$  lit/s
2.  $A_c = 0.25 \times 0.9 = 0.225$  m<sup>2</sup>
3.  $A_s = 0.65 \times 0.25 = 0.1625$
4.  $Q_b = 550$  lit/s
5.  $A_b = 0.15 \times 0.7 = 0.105$
6.  $\frac{A_s}{A_c} = \frac{0.1625}{0.225} = 0.72$
7.  $\frac{A_b}{A_c} = \frac{0.105}{0.25} = 0.42$
8.  $\frac{Q_b}{Q_c} = \frac{550}{1500} = 0.367$

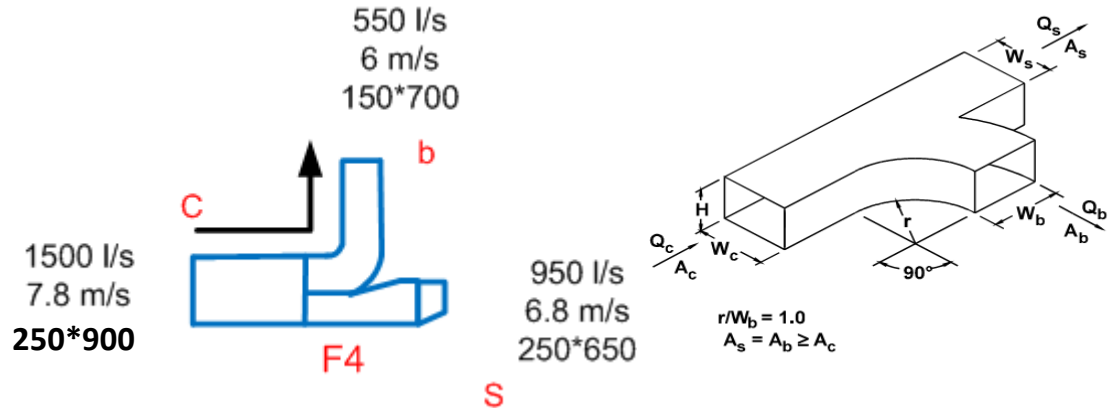

## SR5-1 Smooth Wye of Type $A_s + A_b \geq A_c$ , Branch 90° to Main, Diverging

- $\Delta P = \frac{1}{2} \cdot C_s \rho \cdot C^2$

- $\Delta P(F4) = \frac{1}{2} \cdot 0.47 \times 1.204 \times 7.8^2$

- = 17.2 Pa.

		$C_o$ Values									
		$Q_b/Q_c$									
$A_s/A_c$	$A_b/A_c$	0.1	0.2	0.3	0.4	0.5	0.6	0.7	0.8	0.9	
0.50	0.25	3.44	0.70	0.30	0.20	0.17	0.16	0.16	0.17	0.18	
	0.50	11.00	2.37	1.06	0.64	0.52	0.47	0.47	0.47	0.48	
	1.00	60.00	13.00	4.78	2.06	0.96	0.47	0.31	0.27	0.26	
0.75	0.25	2.19	0.55	0.35	0.31	0.33	0.35	0.36	0.37	0.39	
	0.50	13.00	2.50	0.89	0.47	0.34	0.31	0.32	0.36	0.43	
	1.00	70.00	15.00	5.67	2.62	1.36	0.78	0.53	0.41	0.36	
1.00	0.25	3.44	0.78	0.42	0.33	0.30	0.31	0.40	0.42	0.46	
	0.50	15.50	3.00	1.41	0.62	0.48	0.42	0.40	0.42	0.46	
	1.00	67.00	13.75	5.11	2.31	1.28	0.81	0.59	0.47	0.46	

$C_s = 0.47$

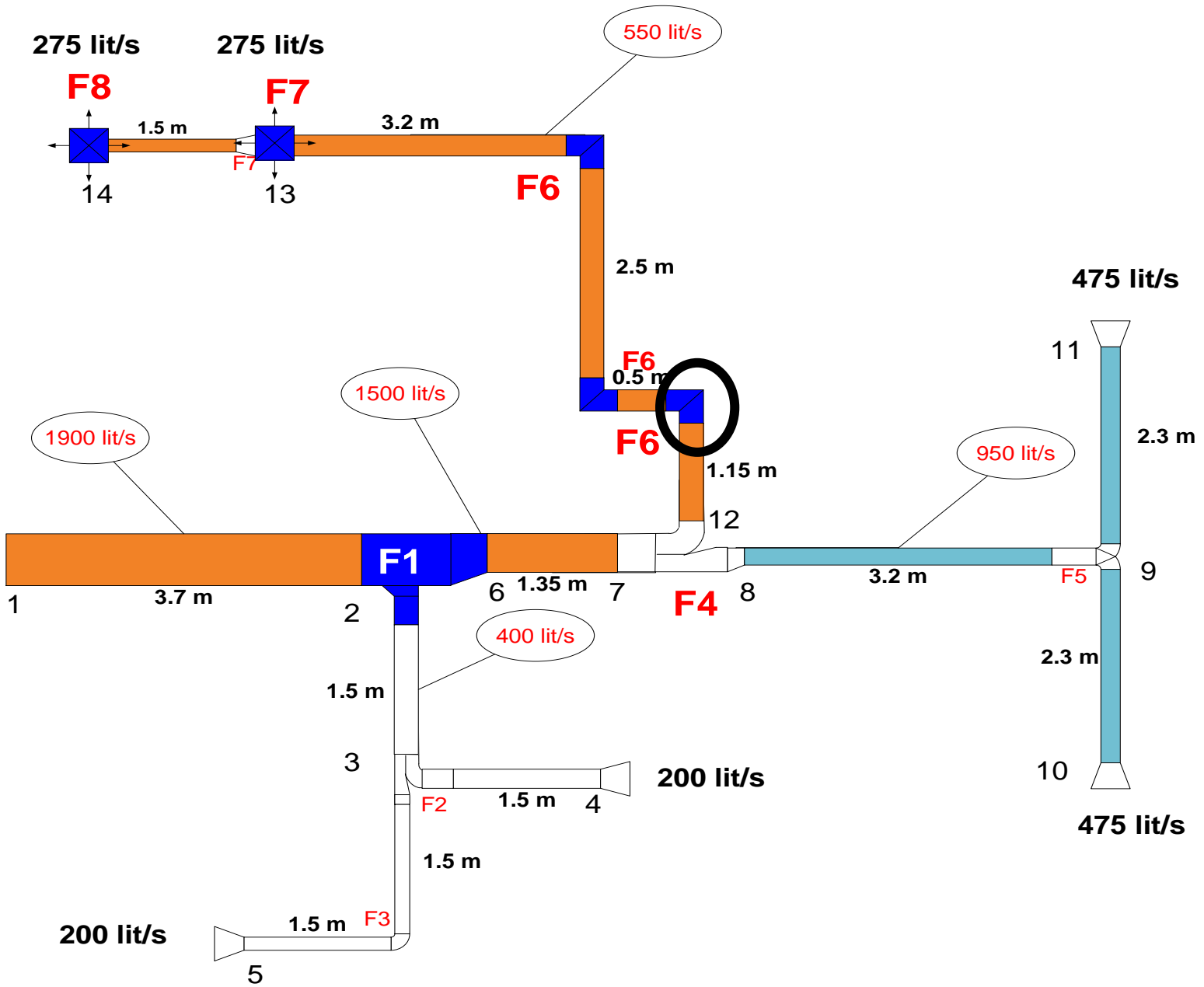

# Fitting F6

CR3-6 Elbow, Mitered

$\theta$	$C_o$ Values										
	$H/W$										
	0.25	0.50	0.75	1.00	1.50	2.00	3.00	4.00	5.00	6.00	8.00
20	0.08	0.08	0.08	0.07	0.07	0.07	0.06	0.06	0.05	0.05	0.05
30	0.18	0.17	0.17	0.16	0.15	0.15	0.13	0.13	0.12	0.12	0.11
45	0.38	0.37	0.36	0.34	0.33	0.31	0.28	0.27	0.26	0.25	0.24
60	0.60	0.59	0.57	0.55	0.52	0.49	0.46	0.43	0.41	0.39	0.38
75	0.89	0.87	0.84	0.81	0.77	0.73	0.67	0.63	0.61	0.58	0.57
90	1.30	1.27	1.23	1.18	1.13	1.07	0.98	0.92	0.89	0.85	0.83

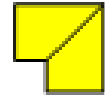
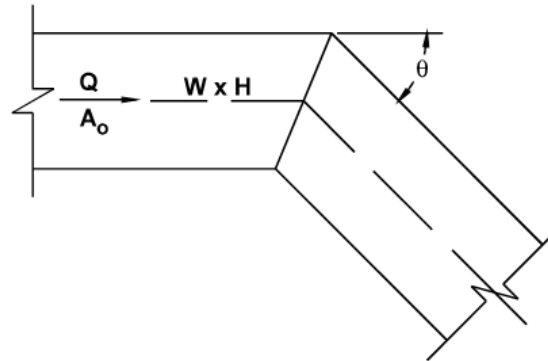

F6

550 l/s  
6 m/s  
150\*700

$C_s = 1.3$

$H = 150$  mm

$W = 700$  mm

$$\frac{H}{W} = \frac{150}{700} = 0.21$$

$$\Delta P = \frac{1}{2} \cdot C_s \rho \cdot C^2$$

$$\Delta P(F6) = \frac{1}{2} \cdot 1.3 \times 1.204 \times 6^2 = 28.17 \text{ Pa.}$$

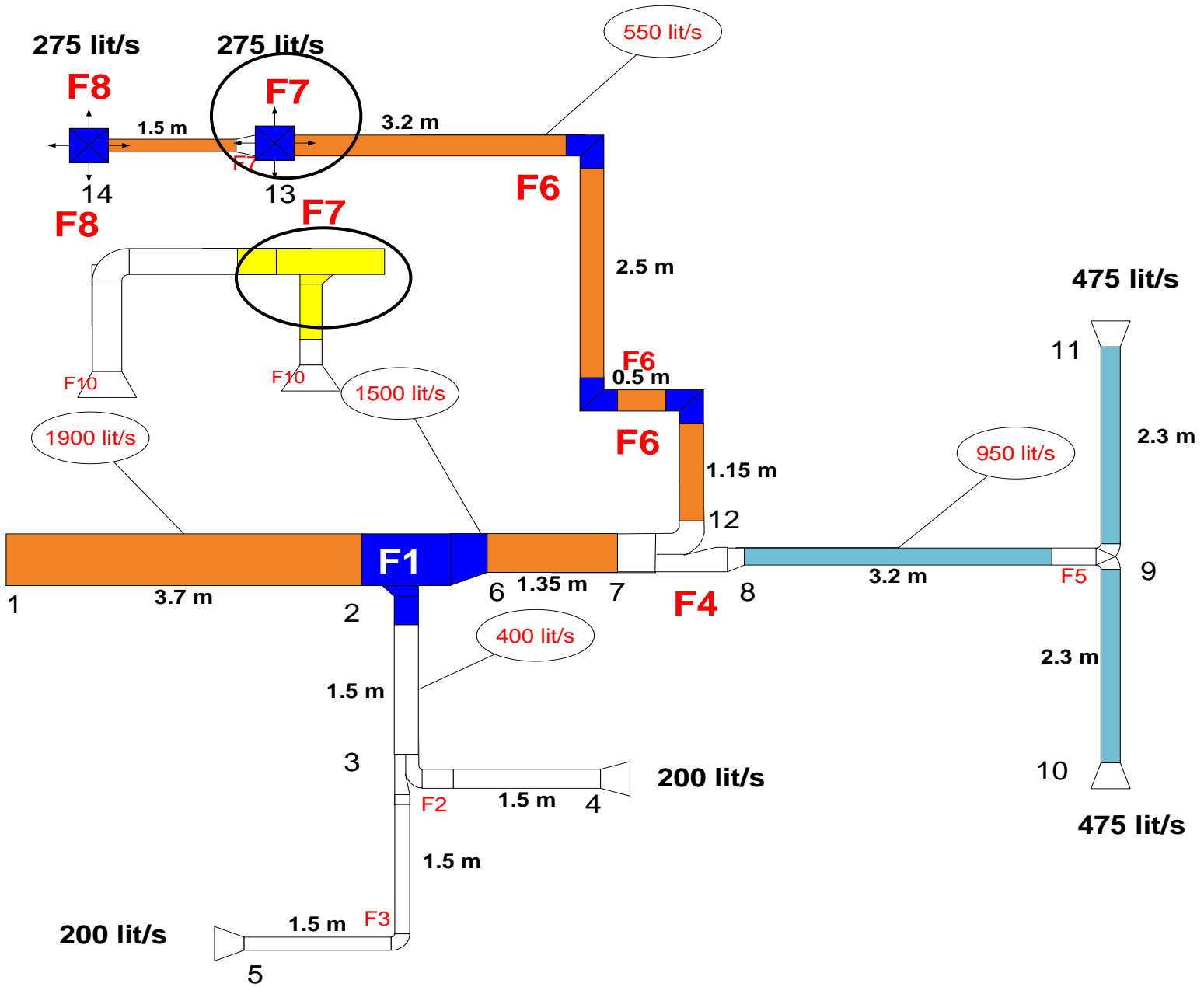

# Fitting F7

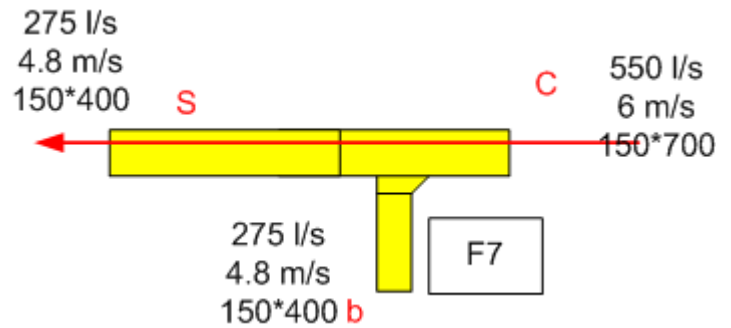

SR5-13 Tee, 45 Degree Entry Branch, Diverging

1.  $Q_c = 550 \text{ lit/s}$
2.  $A_c = 0.7 * 0.15 = 0.105 \text{ m}^2$
3.  $Q_s = 275 \text{ lit/s}$
4.  $A_s = 0.4 * 0.15 = 0.06$

5.  $\frac{A_s}{A_c} = \frac{0.06}{0.105} = 0.57$

6.  $\frac{Q_s}{Q_c} = \frac{275}{550} = 0.5$

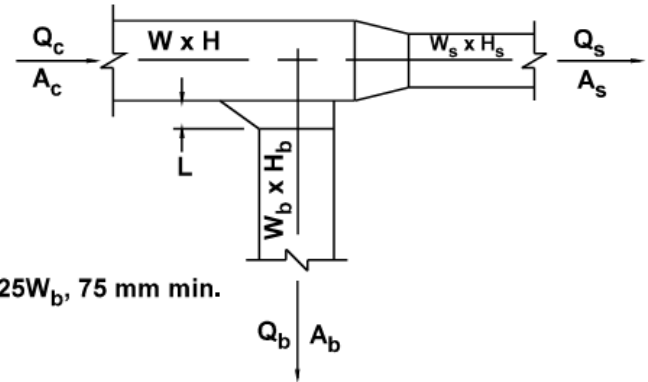

$C_s$  Values

$A_s/A_c$	$Q_s/Q_c$									
	0.1	0.2	0.3	0.4	0.5	0.6	0.7	0.8	0.9	
0.1	0.04									
0.2	0.98	0.04								
0.3	3.48	0.31	0.04							
0.4	7.55	0.98	0.18	0.04						
0.5	13.18	2.03	0.49	0.13	0.04					
0.6	20.38	3.48	0.98	0.31	0.10	0.04				
0.7	29.15	5.32	1.64	0.60	0.23	0.09	0.04			
0.8	39.48	7.55	2.47	0.98	0.42	0.18	0.08	0.04		
0.9	51.37	10.17	3.48	1.46	0.67	0.31	0.15	0.07	0.04	

$C_s = 0.1$

- $\Delta P = \frac{1}{2} \cdot C_s \rho \cdot C^2$
- $\Delta P(F7) = \frac{1}{2} \cdot 0.1 \times 1.204 \times 6^2 = 2.167 \text{ Pa.}$

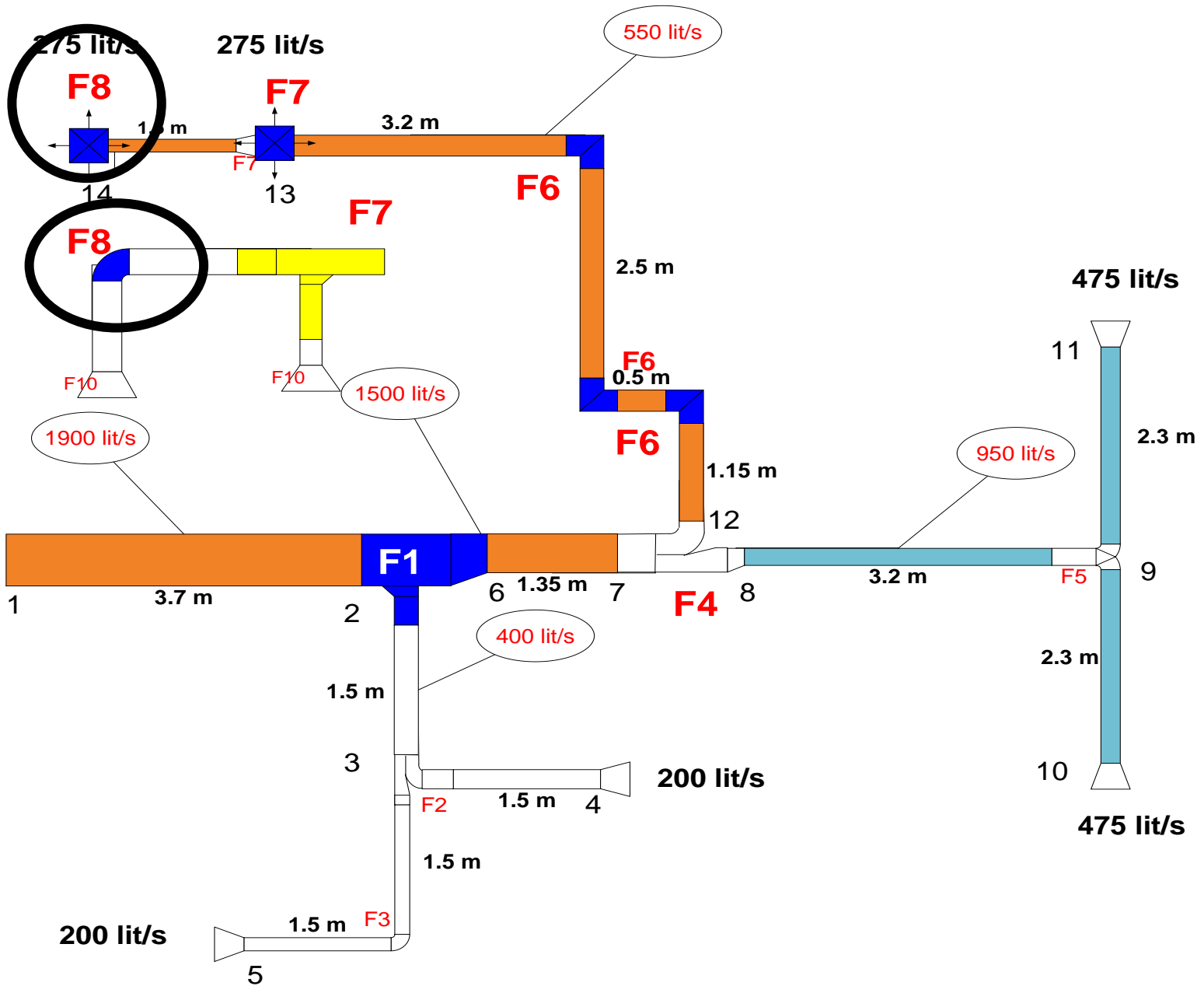

F8

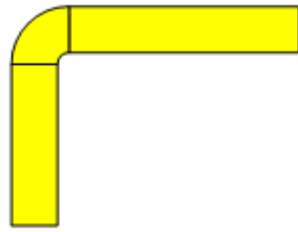

275 l/s  
4.8 m/s  
150\*400

275 l/s  
4.8 m/s  
150\*400

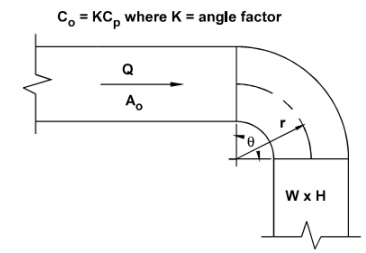

$$H/W = 150/400 = 0.375$$

$$r/W = 1.5$$

$$\theta = 90$$

$$C_p = 0.22$$

$$K = 1$$

$$\Delta P = \frac{1}{2} \cdot K C_p \rho \cdot C^2$$

$$= \frac{1}{2} \times 1 \times 0.22 \times 1.204 \times 4.8^2$$

$$= 3.05 \text{ Pa.}$$

CR3-1 Elbow, Smooth Radius, Without Vanes

		C <sub>p</sub> Values										
		H/W										
r/W		0.25	0.50	0.75	1.00	1.50	2.00	3.00	4.00	5.00	6.00	8.00
0.50		1.53	1.38	1.29	1.18	1.06	1.00	1.00	1.06	1.12	1.16	1.18
0.75		0.57	0.52	0.48	0.44	0.40	0.39	0.39	0.40	0.42	0.43	0.44
1.00		0.27	0.25	0.23	0.21	0.19	0.18	0.18	0.19	0.20	0.21	0.21
1.50		0.22	0.20	0.19	0.17	0.15	0.14	0.14	0.15	0.16	0.17	0.17
2.00		0.20	0.18	0.16	0.15	0.14	0.13	0.13	0.14	0.14	0.15	0.15
		Angle Factor K										
θ		0	20	30	45	60	75	90	110	130	150	180
K		0.00	0.31	0.45	0.60	0.78	0.90	1.00	1.13	1.20	1.28	1.40



# Pressure loss due fittings

- $\Delta P_{t,f} = 3.044 + 17.2 + 3(28.17) + 2.167 + 3.05 = 110 \text{ Pa}$
- Pressure loss due duct length = duct length \* Friction loss per meter
- $= 13.9 * 1.2 = 17 \text{ Pa}$
- $\Delta P_t = 110 + 17 = 127 \text{ Pa}$ .