



كلية المستقبل الجامعة
قسم تقنيات الأشعة
فصله عملي

المحاضرة الأولى

Introduction to the Microscope

Assist. Lecturer Doa'a Adil Almusawi

2022-2023

A microscope is an instrument used to see objects that are too small to be seen by the naked eye.

. Microscopy is the science of investigating small objects and structures using such an instrument

Light microscope is a type of microscope that used to magnified object by using the visible light and lenses system, visible light is passed through the object and then through glass lenses.

Types of Microscopes

- Light Microscope
- Dissection Microscope
- Scanning Electron Microscope (SEM)
- Transmission Electron Microscope (TEM)

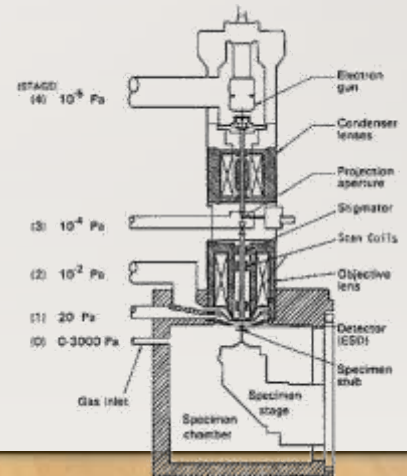
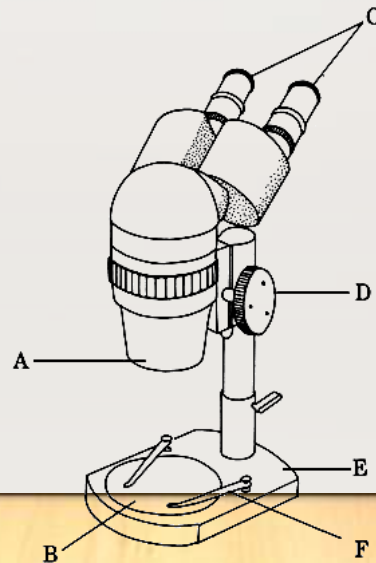

Microscope Care

- ❖ Always carry with 2 hands
- ❖ Never touch the lenses with your fingers.
- ❖ Only use lens paper for cleaning
- ❖ Always store covered
- ❖ Turn the instrument off when it is not in use



Microscope Parts

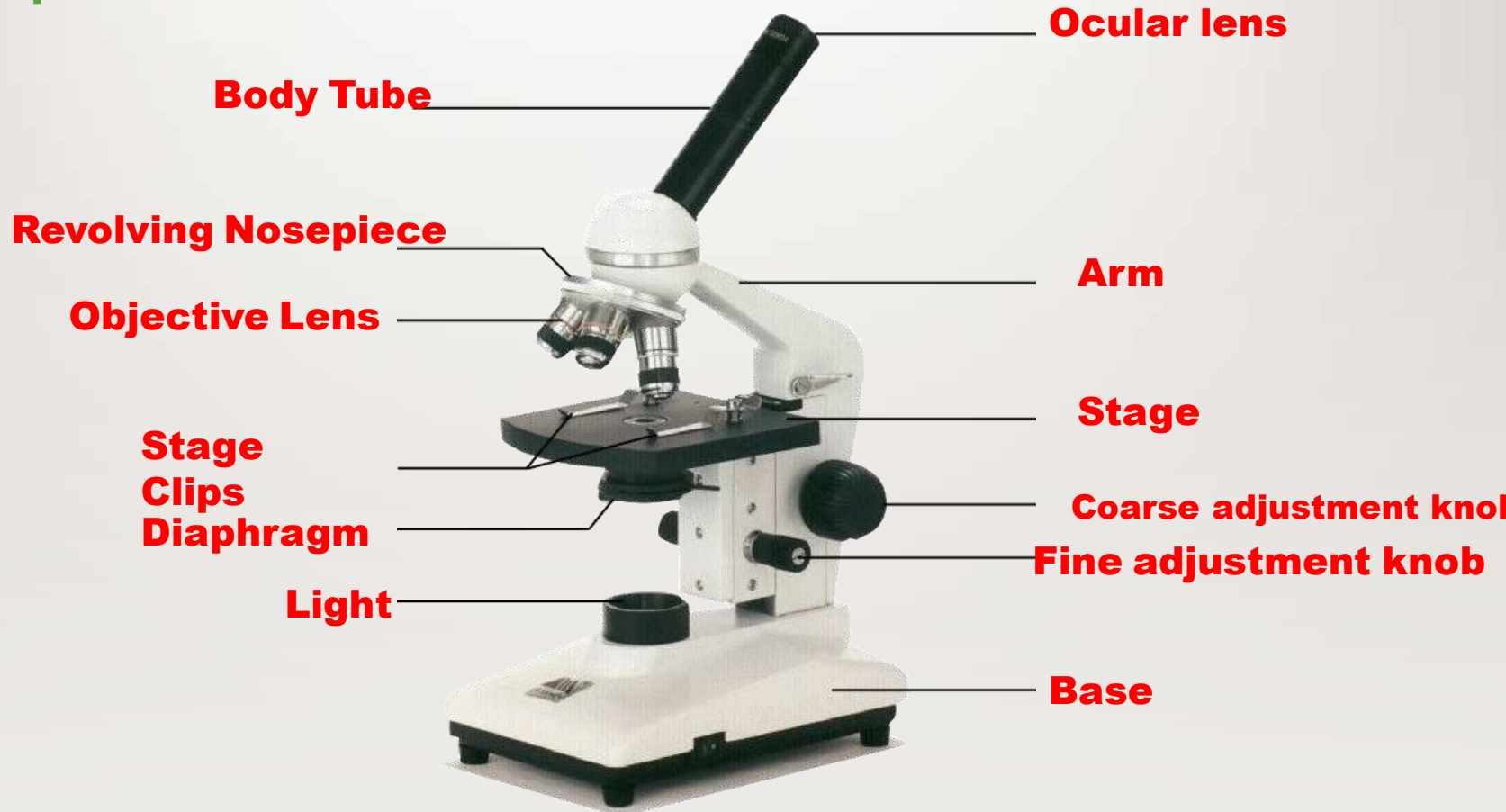

Ocular Lence

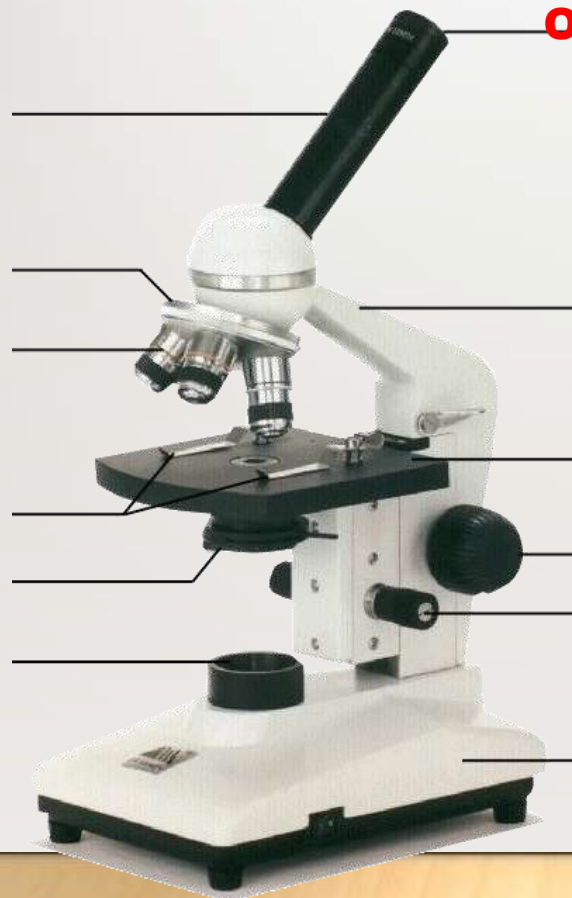

Ocular lence

magnifies; where you look through to see the image of your specimen.

They are usually 10X

A r m



supports the tube and
connects it to the
base

stage

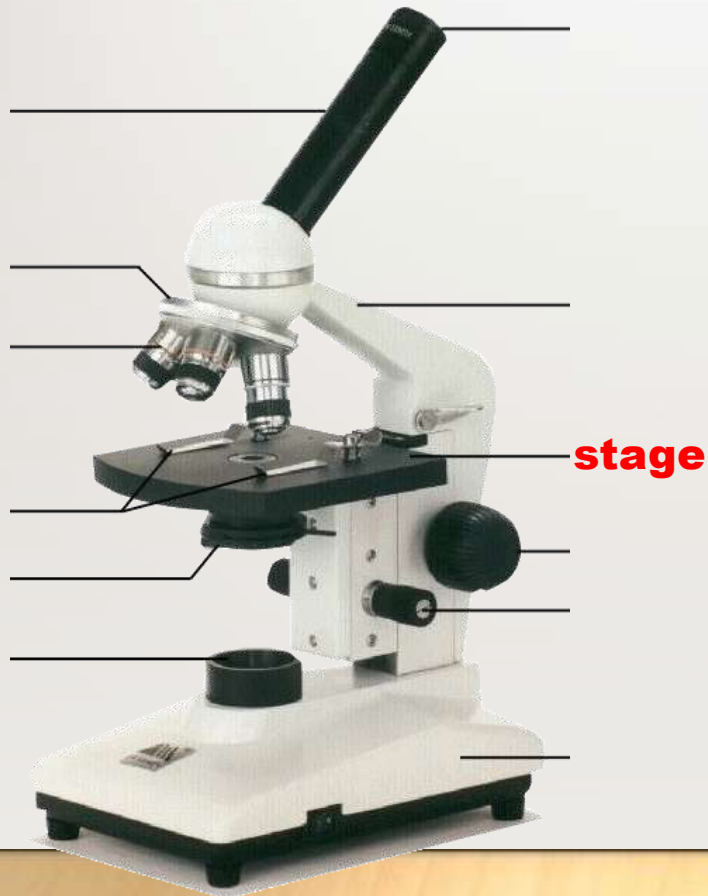

the flat platform
where you place
your slides

coarse adjustment knob

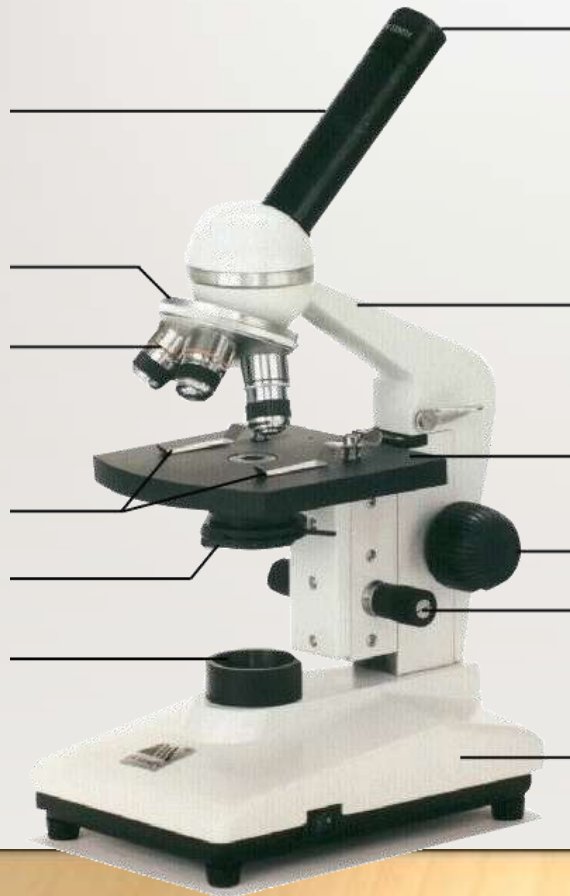

moves stage (or body tube) up and down

coarse adjustment knob

fine adjustment knob

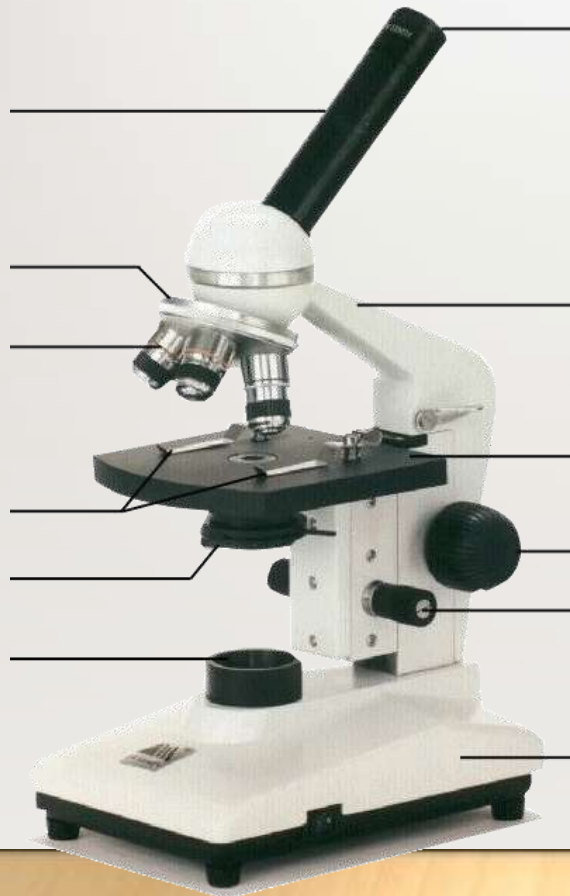

small, round knob on the side of the microscope used to fine-tune the focus of your specimen

fine adjustment knob

after using the coarse adjustment knob

base

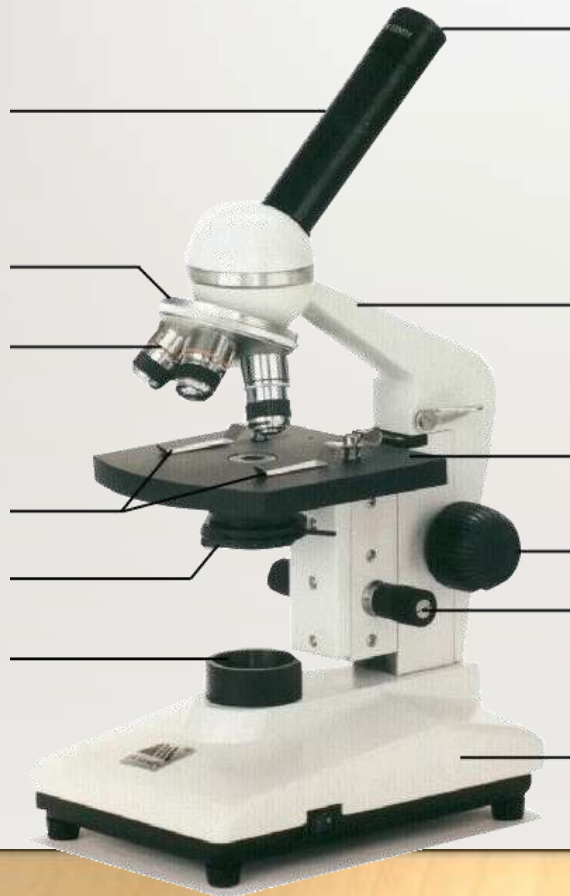

the bottom of the microscope, used for support

base

body tube

body tube

connects the eyepiece
to the objective
lenses

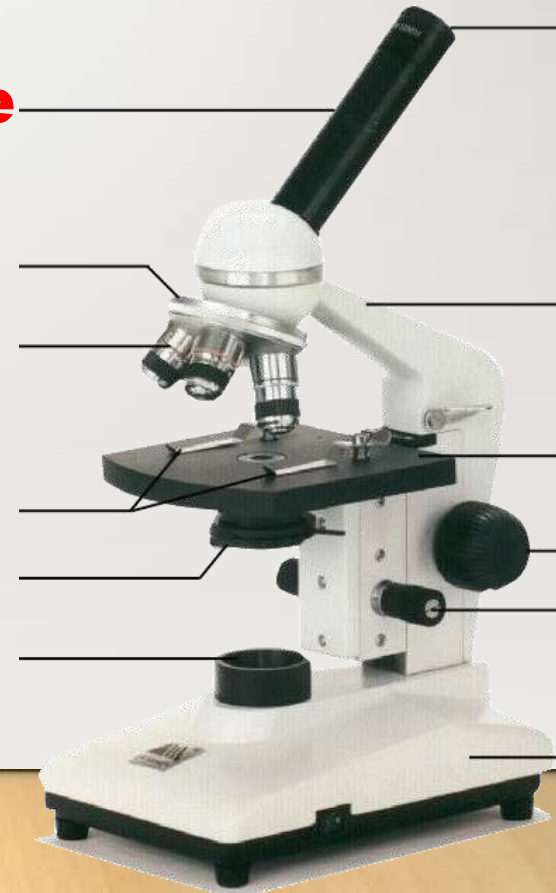

revolving nosepiece

the part that holds two
or more objective lenses

revolving nosepiece

and can be rotated to
easily change power

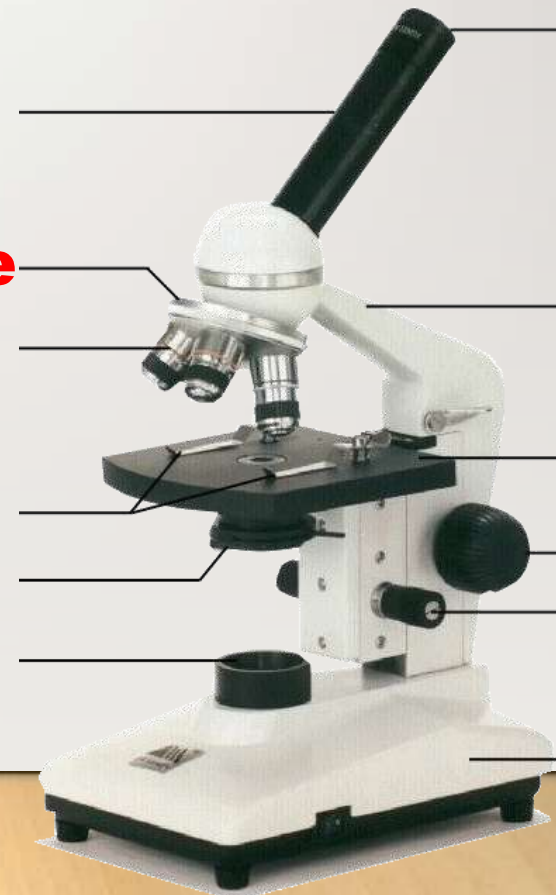

objective lenses

used to the magnifies

Usually you will find 3 or 4 objective lenses on a microscope. They almost

objective lens

always consist of 4X, 10X, 40X and 100X powers.

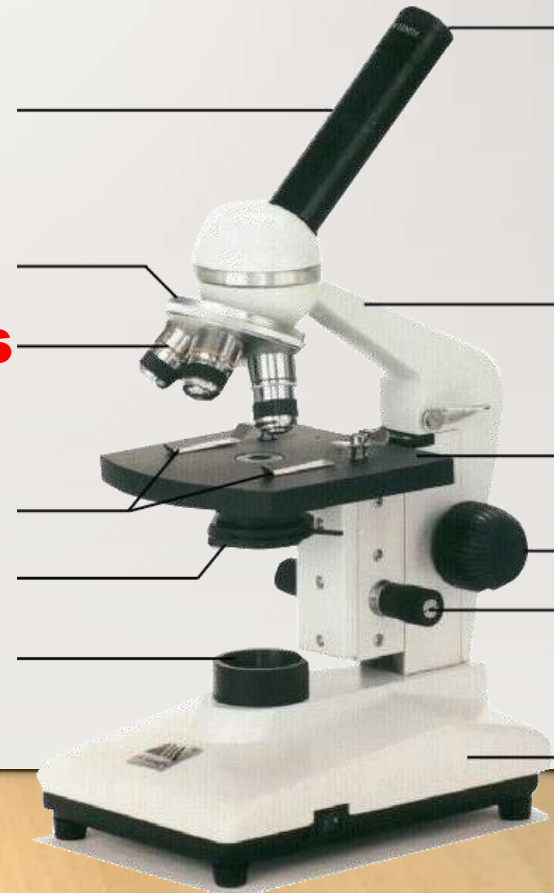

stage clips

Stage clips hold the slides in place. If your microscope has a mechanical stage, you will be able to move the slide around by turning two knobs. One **stage clips** moves it left and right, the other moves it up and down.



light

makes the specimen
easier to see

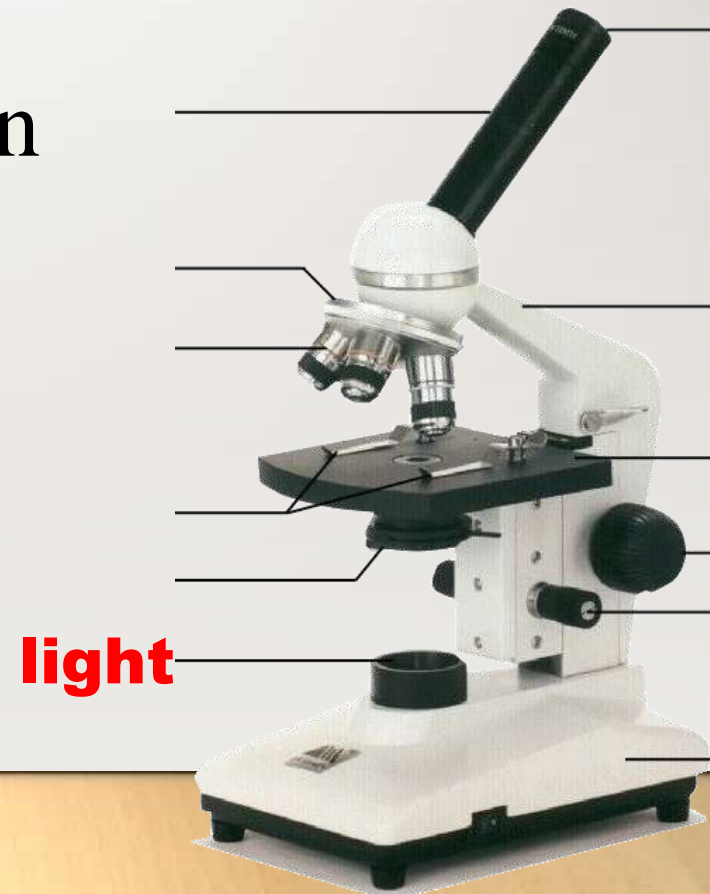

- **Magnification** is the ratio of an object's image size to its real size

- Magnification power Of microscope =

Magnification power of eye piece × Magnification power of objective lens

Blood Smear under light microscope

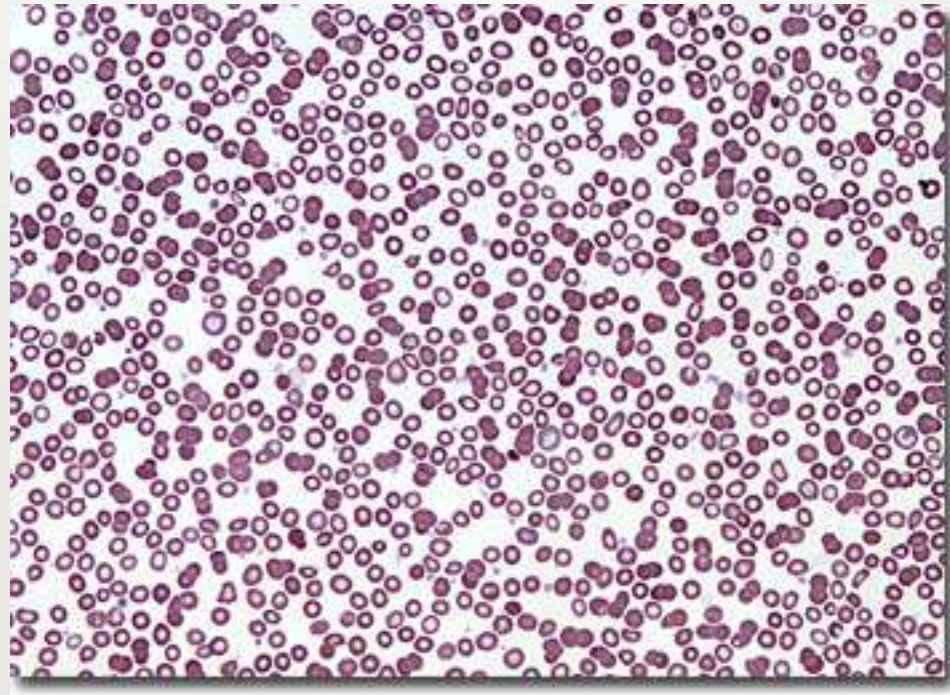

Electron microscope



©Eric B. Workman

- Dissection Microscope



Blood smear under electron microscop

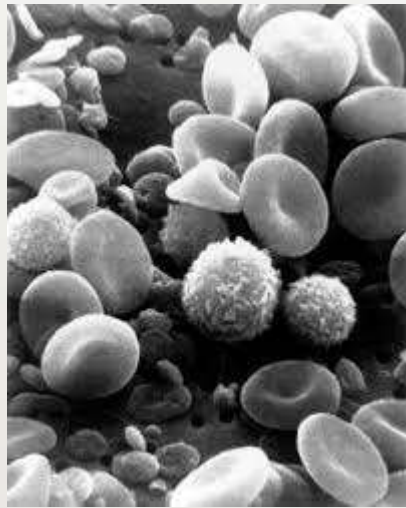





Thank You