



## Set up

### 1- Analysis systems → fluid flow (fluent) → setup.

The screenshot shows the ANSYS Workbench interface. The 'Project Schematic' window displays a sequence of steps: 1. Fluid Flow (Fluent), 2. Geometry, 3. Mesh, 4. Setup, 5. Solution, and 6. Results. The 'Setup' step is highlighted. The 'Properties of Schematic A4: Setup' dialog box is open, showing a table of properties and values.

Property	Value
Component ID	Setup
Directory Name	FFF
Precision	Sin...
Show Launcher at Startup	<input checked="" type="checkbox"/>
Display Mesh After Reading	<input checked="" type="checkbox"/>
Embed Graphics Windows	<input checked="" type="checkbox"/>
Use Workbench Color Scheme	<input checked="" type="checkbox"/>
Environment Path	
Setup Completion Environment for UDF	<input checked="" type="checkbox"/>
Use Job Scheduler	<input type="checkbox"/>
Run Parallel Version	<input type="checkbox"/>
UDF Compilation Script Path	\$(FLUENT)\\$(ARCH)\udf.bat
Query/Result	
Notes	
Used Licenses	
Last Update Used Licenses	
Others	
Generate Output Case File	<input checked="" type="checkbox"/>

The screenshot shows the ANSYS Workbench interface with the 'Fluent Launcher' dialog box open. The dialog box has several sections: Dimension (2D or 3D), Options (Double Precision, Use Job Scheduler, Use Remote Linux Nodes), Display Options (Display Mesh After Reading, Embed Graphics Windows, Workbench Color Scheme, Do not show this panel again), Processing Options (Serial or Parallel (Local Machine)), Solver (Processes, GPGPUs per Machine), and Show More Options. The 'Parallel (Local Machine)' option is selected.



Class: third Stage  
Lecturer: Wurood yassin Mohsin  
E-mail:wurood.yassin@mustaqbal-college.edu.iq

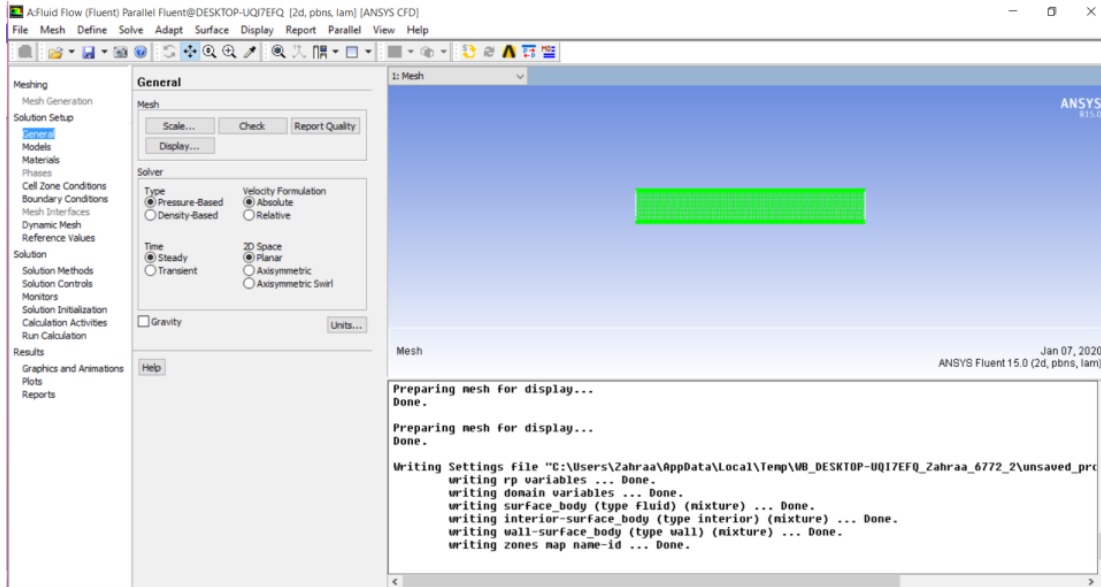

2- Setup → models → energy(off) → edit energy(on) → ok.

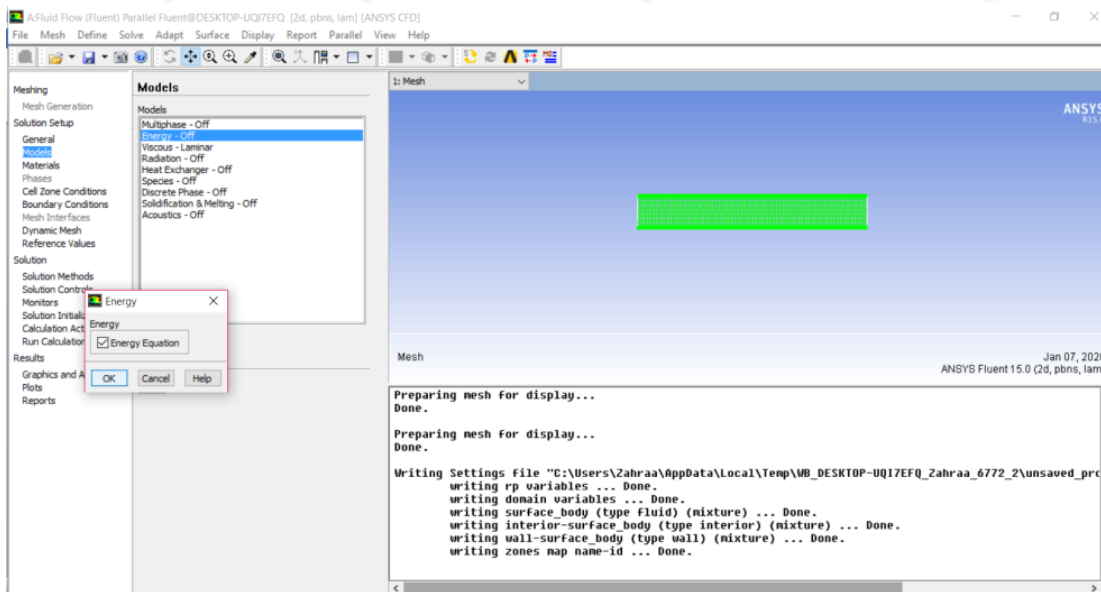



3- Setup → Materials → Create/Edit → Fluent Database → liquid (water) → Copy → Close → Close.

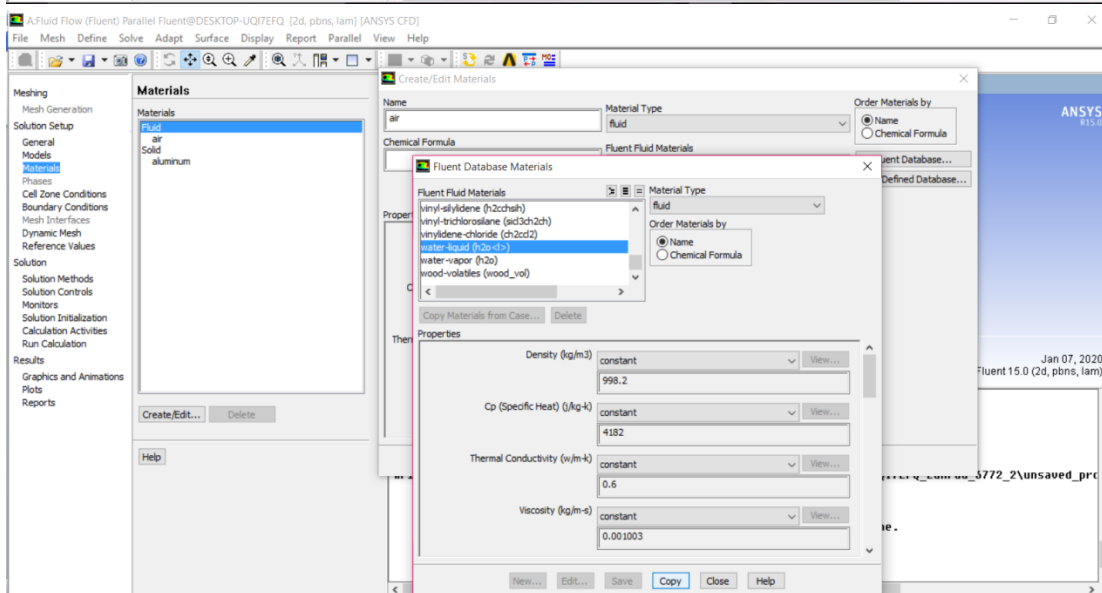
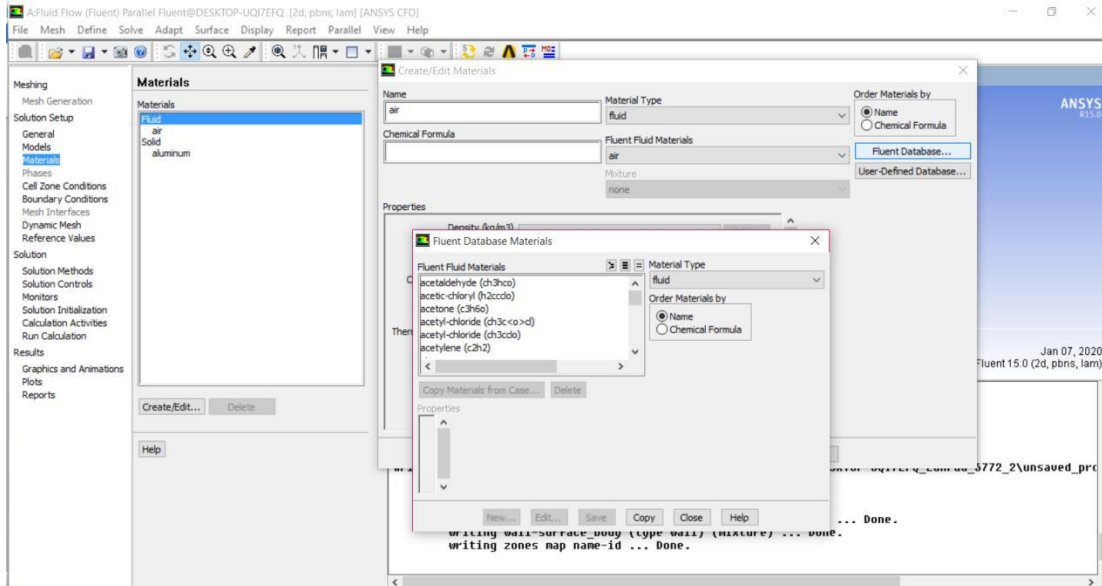



4- Setup → Boundary Condition → inlet → Velocity inlet → edit → Momentum (mount of velocity) → (Thermal (Temperature) Ok.

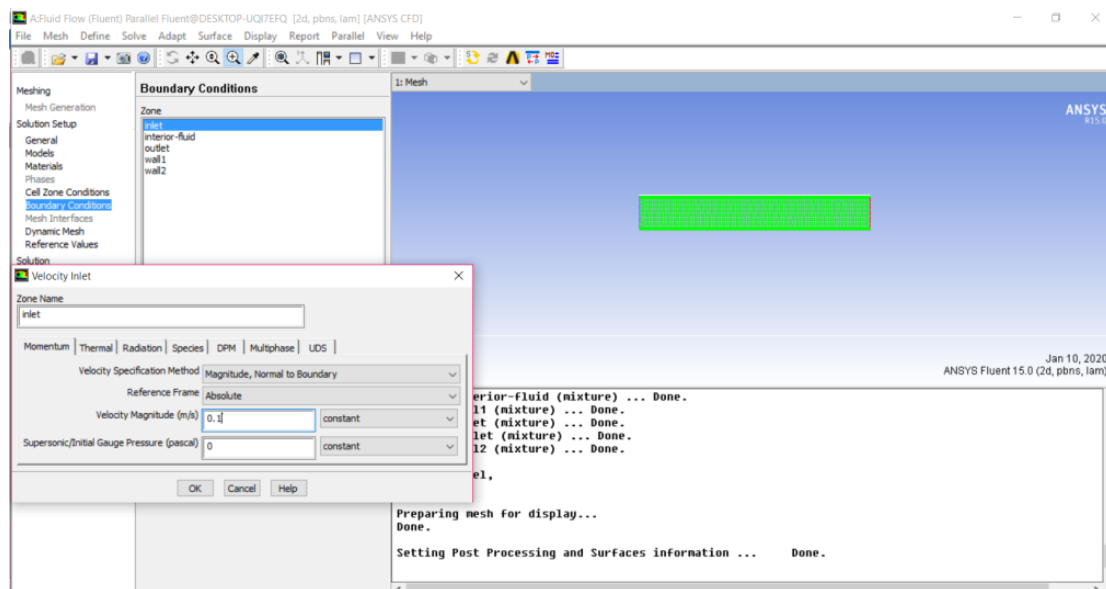
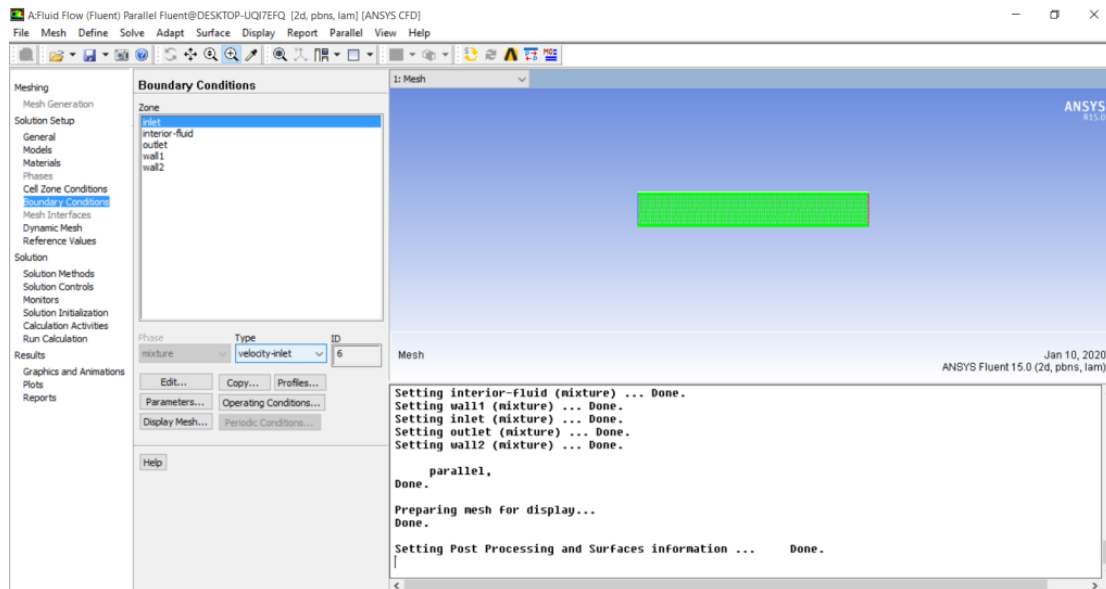



Class: third Stage  
Lecturer: Wurood yassin Mohsin  
E-mail:wurood.yassin@mustaqbal-college.edu.iq

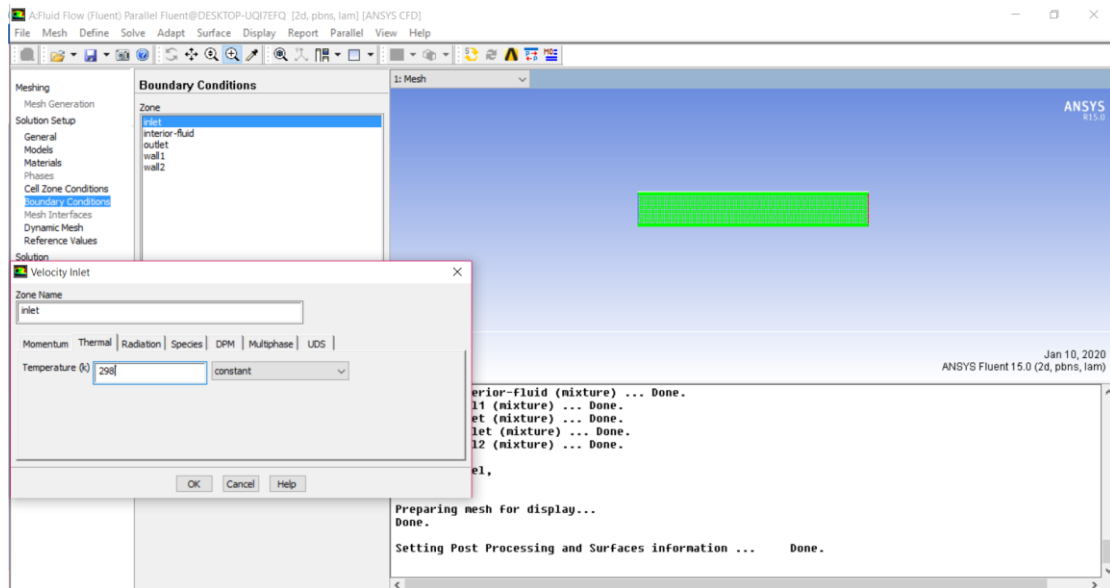

5- Setup → Boundary Condition → outlet → Pressure outlet → edit → Momentum (mount of pressure) → (Thermal (Temperature) Ok.

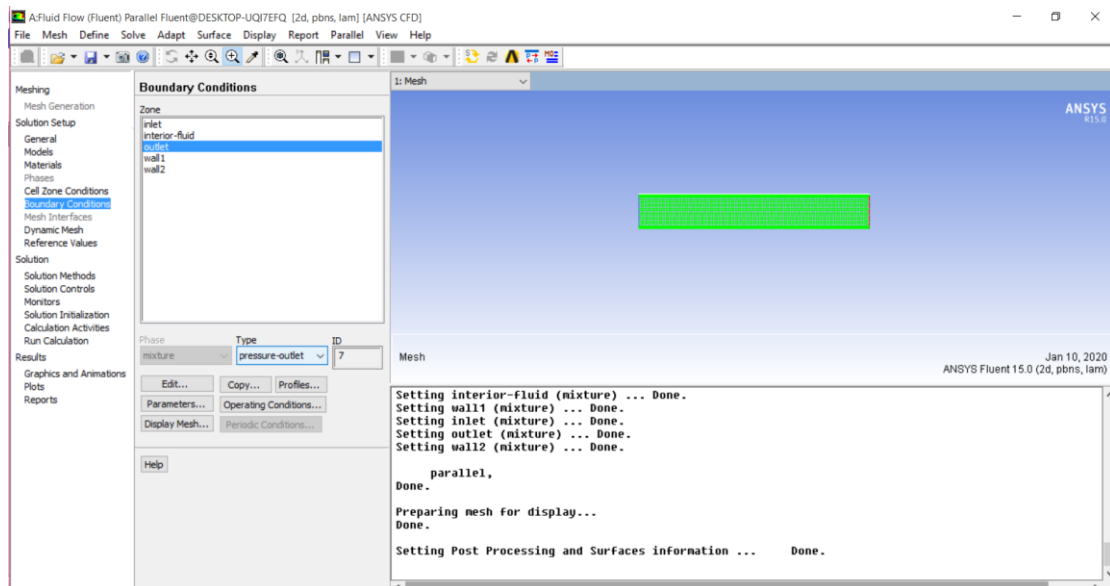



Class: third Stage  
Lecturer: Wurood yassin Mohsin  
E-mail:wurood.yassin@mustaqbal-college.edu.iq

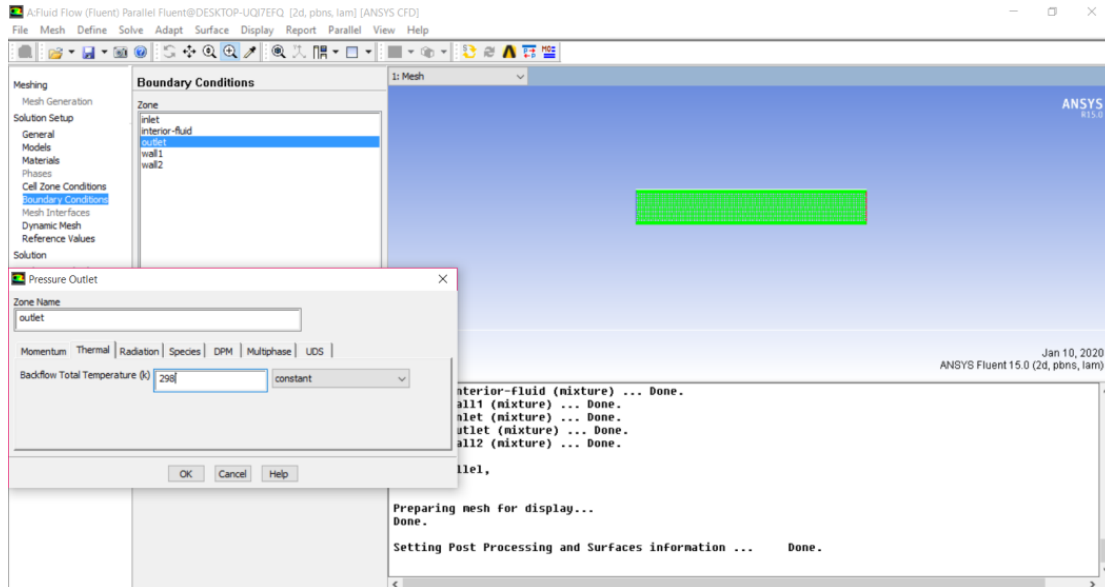

6- Setup  $\longrightarrow$  Boundary Condition  $\longrightarrow$  wall  $\longrightarrow$  heat flux (amount of heat)  $\longrightarrow$  Ok.

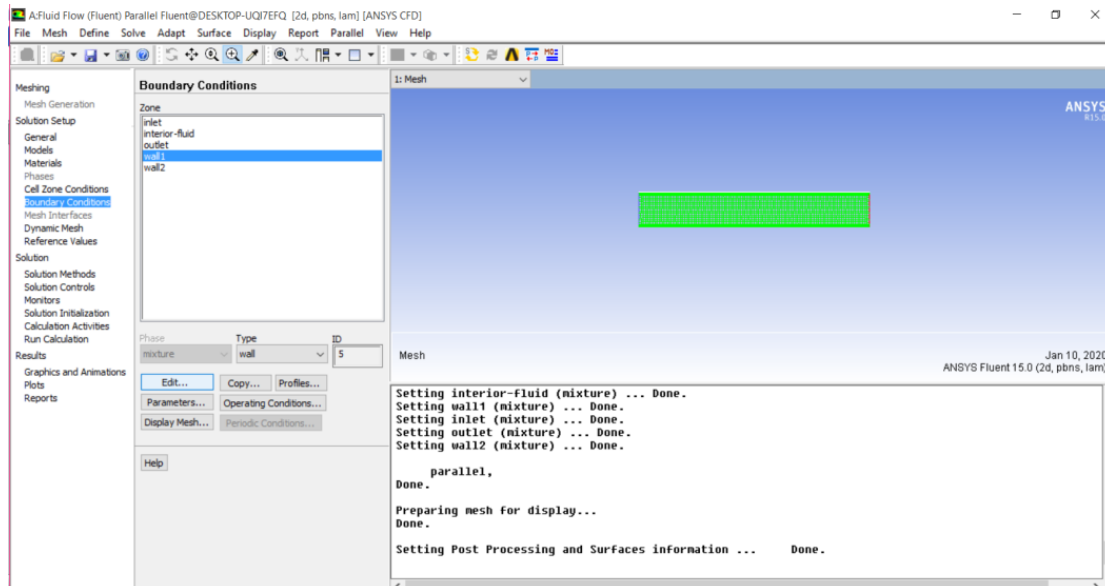



Class: third Stage  
Lecturer: Wuwood yassin Mohsin  
E-mail:wuwood.yassin@mustaqbal-college.edu.iq

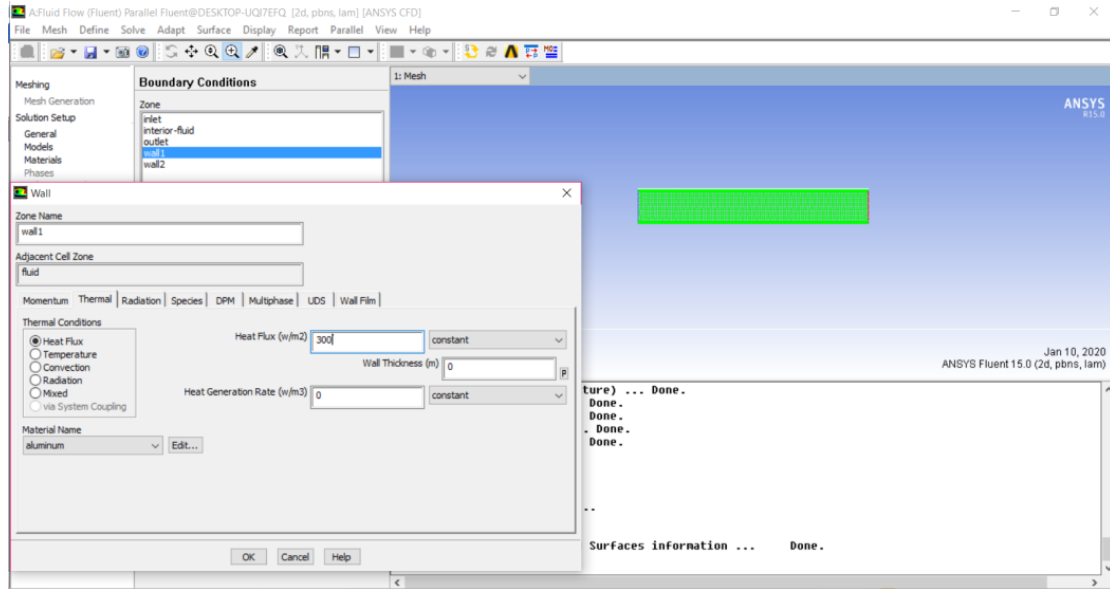

7- Setup → Run Calculation → Number of Iteration → Calculate.

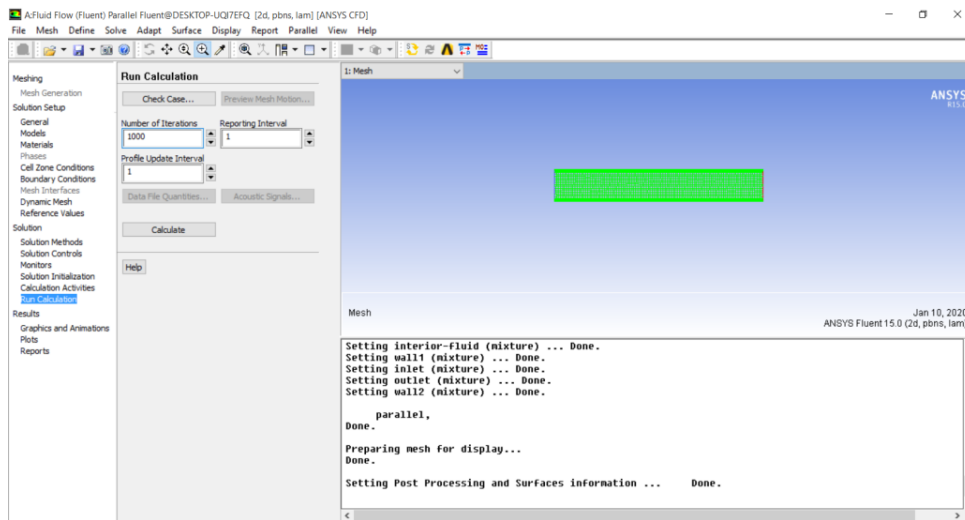



Class: third Stage  
Lecturer: Wuood yassin Mohsin  
E-mail:wurood.yassin@mustaqbal-college.edu.iq

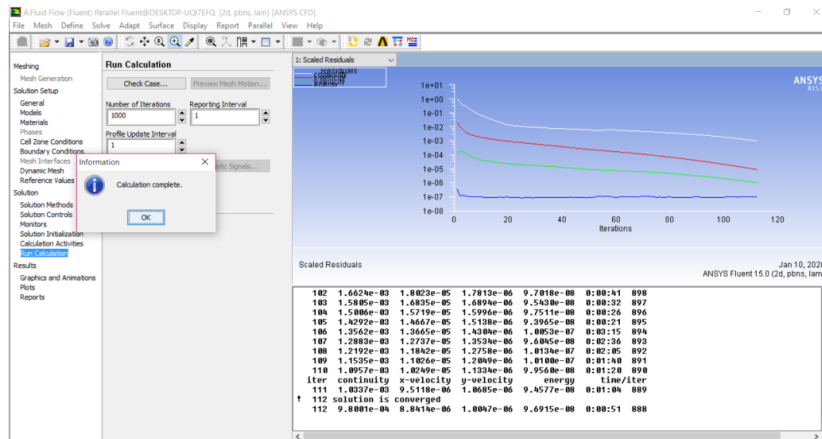

## Results

8- Analysis systems → fluid flow (fluent) → Results

Workbench Project Schematic showing the analysis system hierarchy:

- 1 Fluid Flow (Fluent)
- 2 Geometry
- 3 Mesh
- 4 Setup
- 5 Solution
- 6 Results

Properties of Schematic A6: Results

Property	Value
Always Include in Design Point Update	<input type="checkbox"/>
Component ID	Results
Directory Name	FFF
Notes	
Used Licenses	
Last Update Used Licenses	Not Applicable
Update Options	
Clear State	<input type="checkbox"/>
Load Report	None
Publish Report	<input type="checkbox"/>

Progress table:

	A	B	C
1	Status	Details	Progress





Class: third Stage  
Lecturer: Wuhood yassin Mohsin  
E-mail: wuhood.yassin@mustaqbal-college.edu.iq

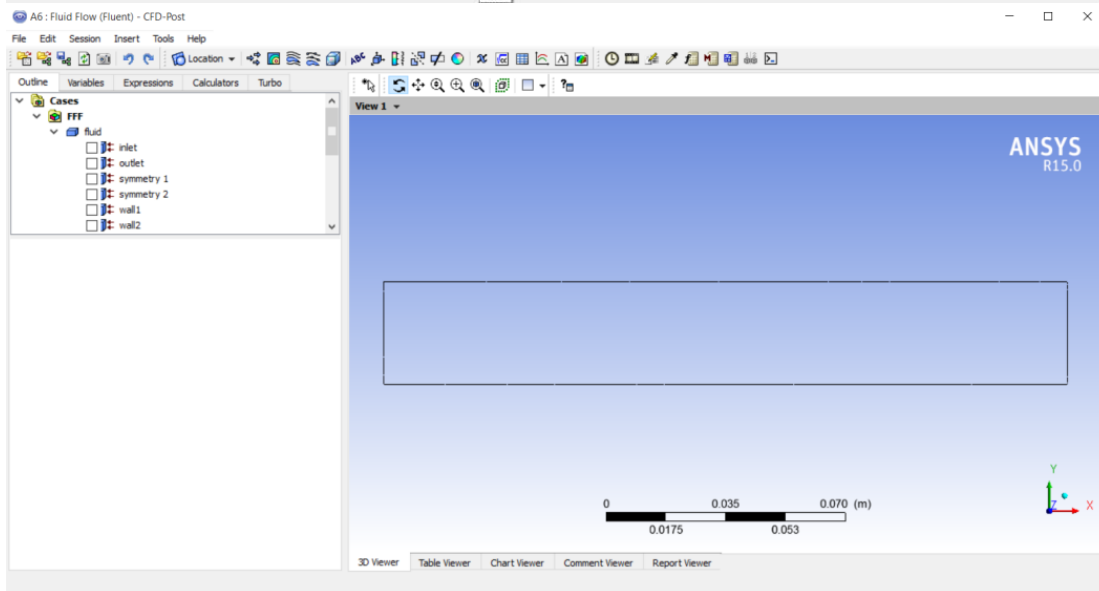
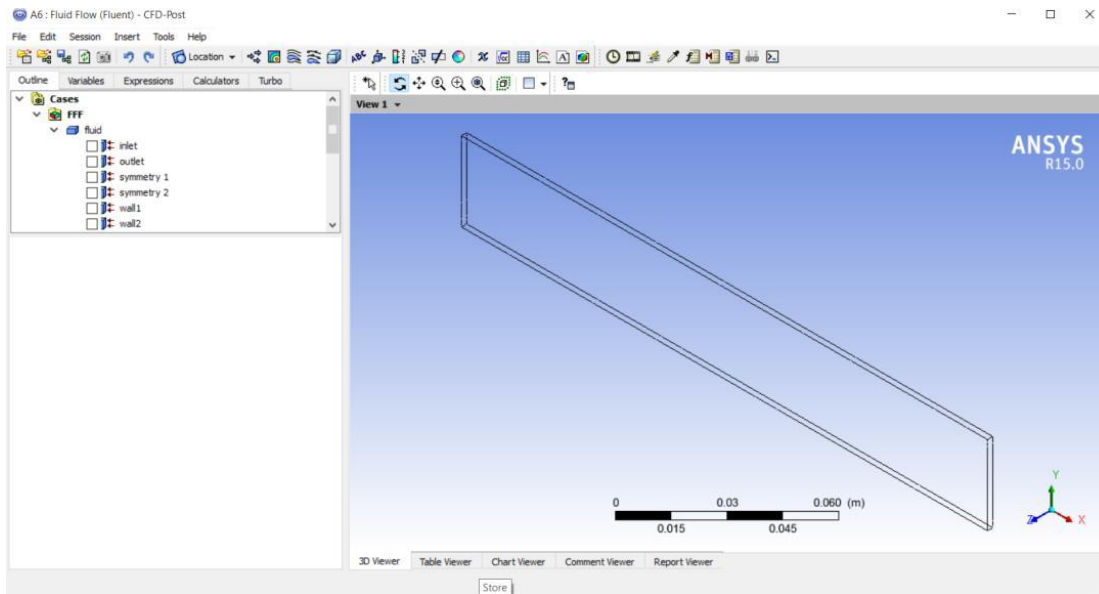



9- Results → Contour → create name (velocity) → ok

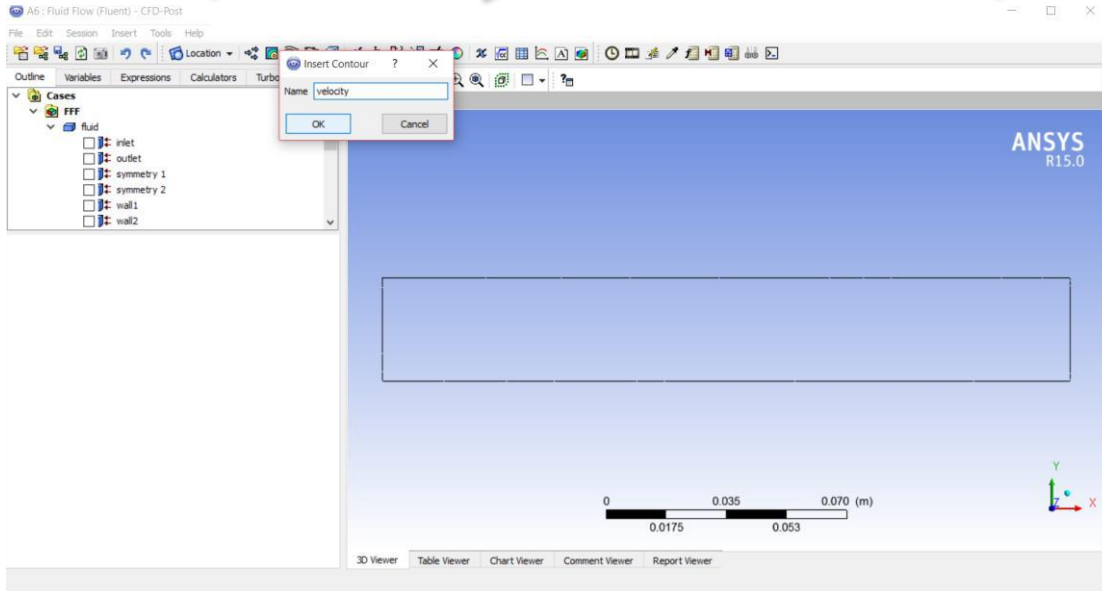

10- Location (select all) → ok → variable (select velocity) → apply

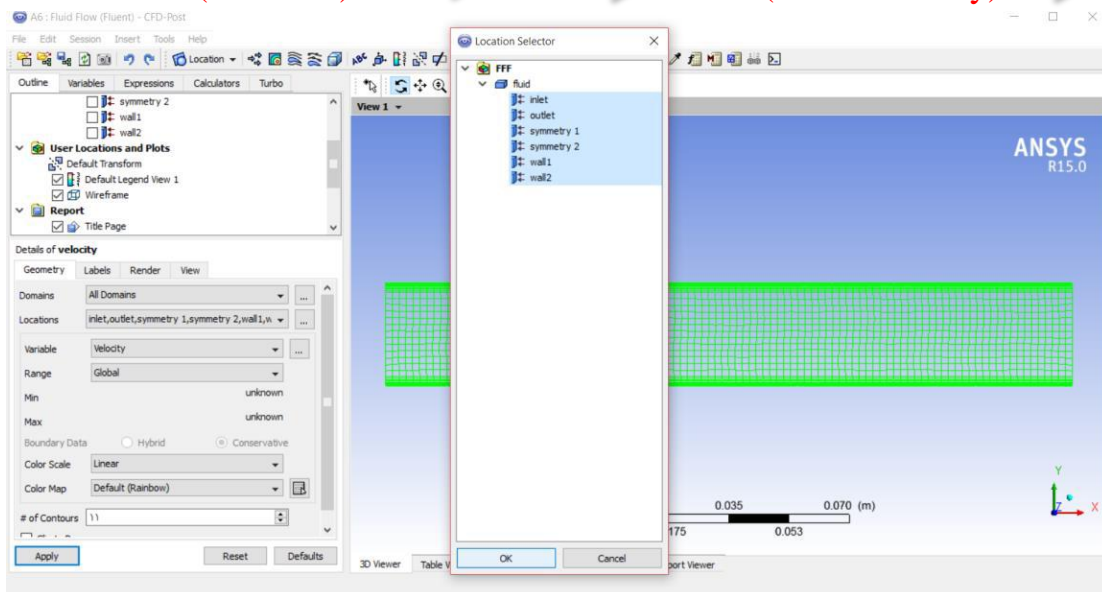



Class: third Stage  
Lecturer: Wurood yassin Mohsin  
E-mail: wurood.yassin@mustaqbal-college.edu.iq

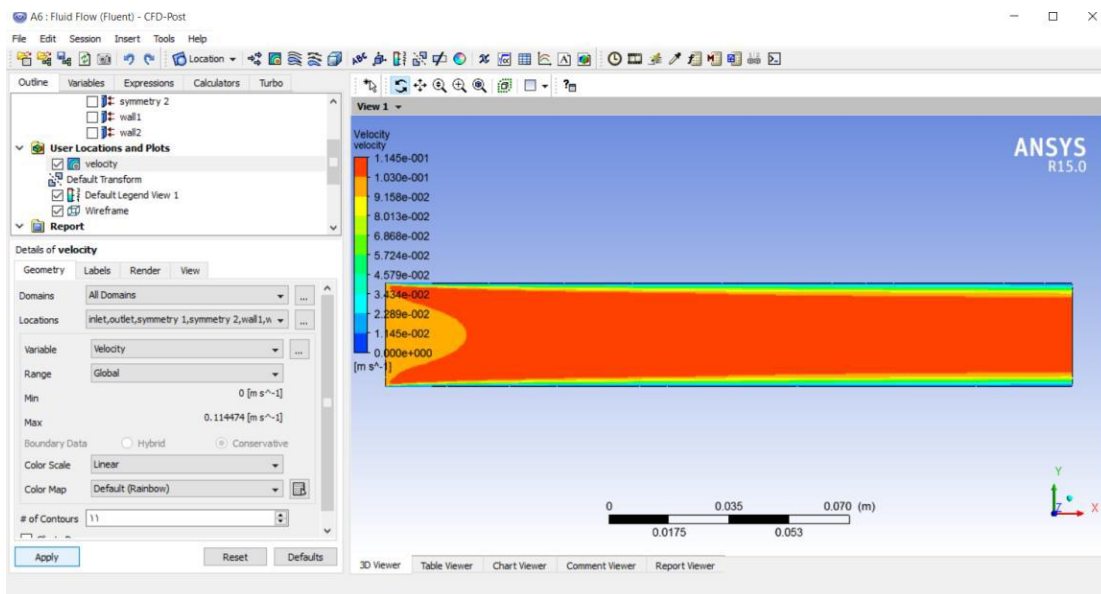
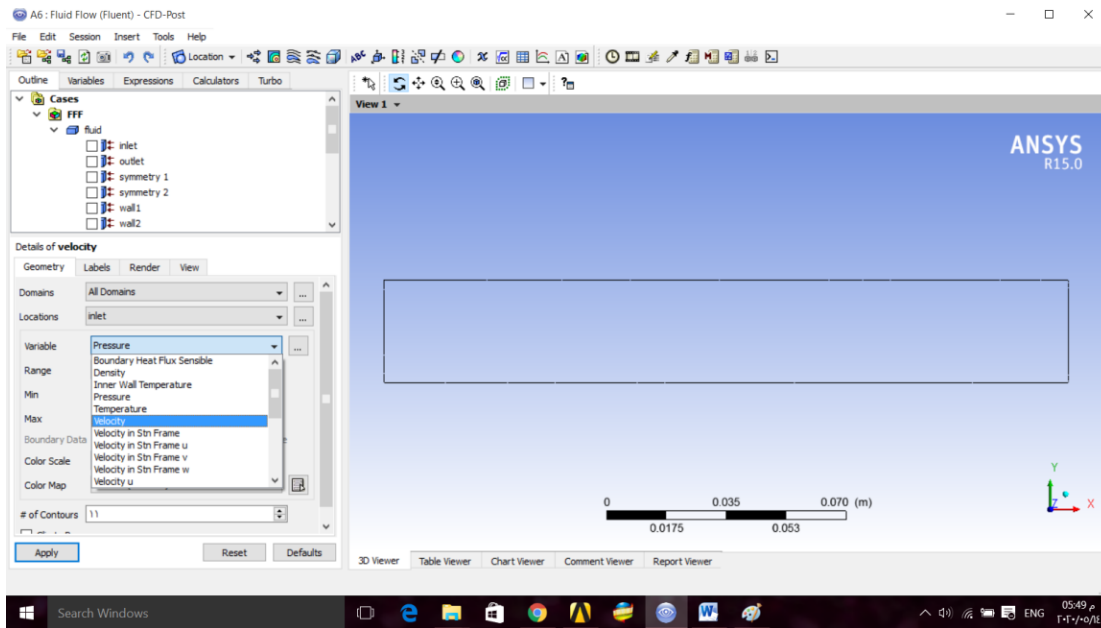



### 11- Remove mark of true from velocity

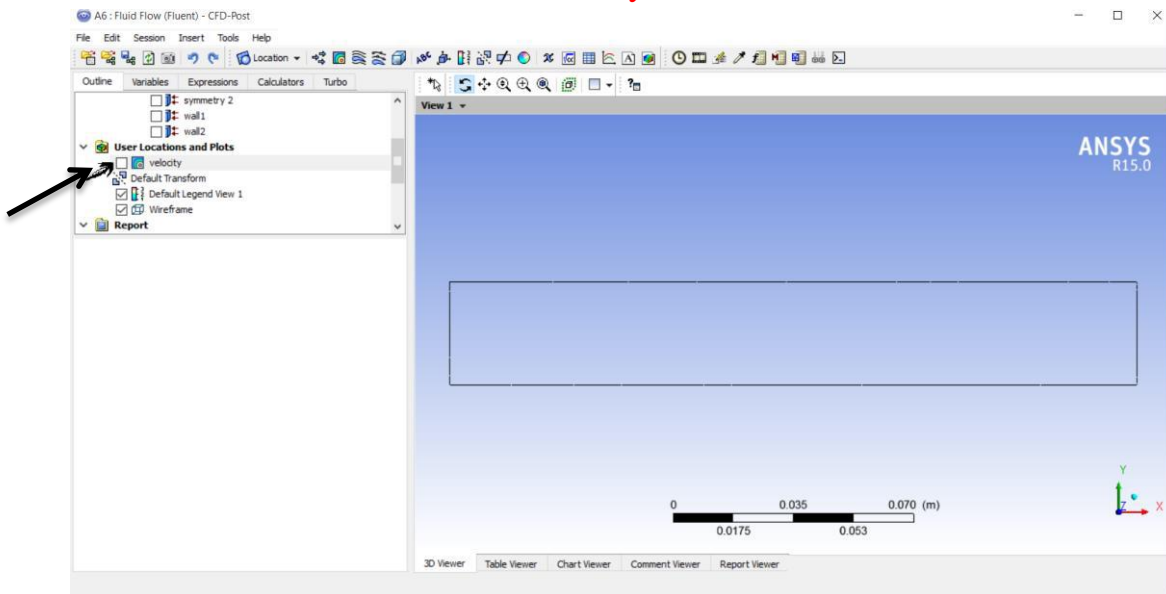

### 12- Results → Contour → create name (pressure) → ok

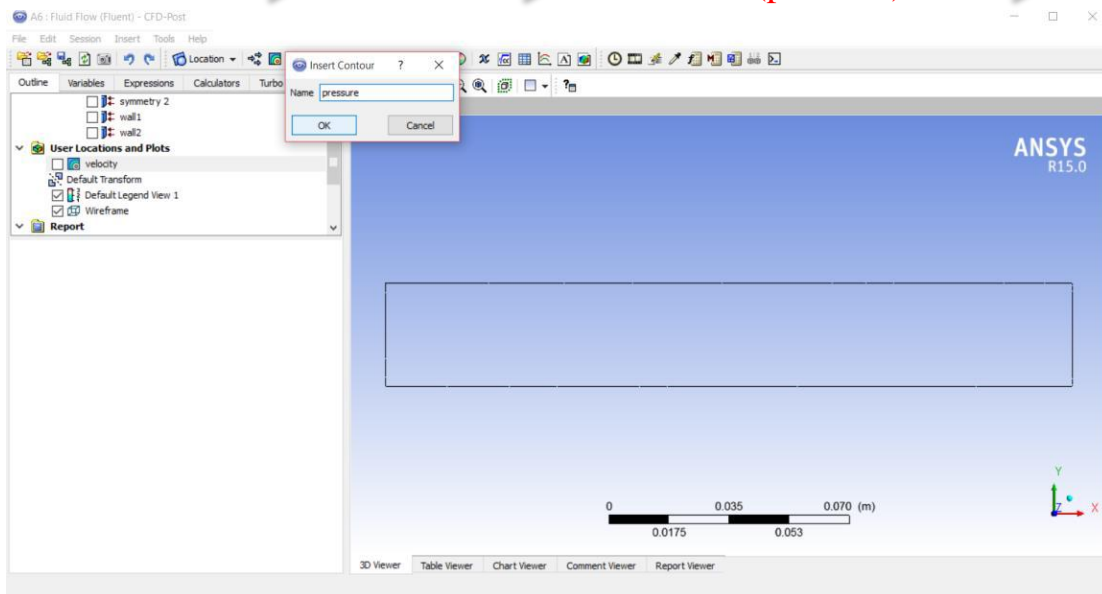



13- Location (select all) → ok → variable (select pressure) → apply

The image displays three sequential screenshots of the ANSYS Fluent interface, illustrating the steps to set up a pressure location for a CFD simulation.

**Top Screenshot:** The 'Location Selector' dialog box is open, showing a list of locations: fluid, inlet, outlet, symmetry 1, symmetry 2, wall 1, and wall 2. The 'fluid' location is selected. The 'Details of pressure' panel on the left shows 'Domains' set to 'All Domains', 'Locations' set to 'inlet', 'Variable' set to 'Pressure', and 'Range' set to 'Global'. The 'Apply' button is highlighted.

**Middle Screenshot:** The 'Location Selector' dialog box is closed. The 'Details of pressure' panel shows 'Locations' set to 'inlet,outlet,symmetry 1,symmetry 2,wall 1,w'. The 'Variable' dropdown is set to 'Pressure'. The 'Apply' button is highlighted.

**Bottom Screenshot:** The 'Details of pressure' panel shows 'Locations' set to 'inlet,outlet,symmetry 1,symmetry 2,wall 1,w'. The 'Variable' dropdown is set to 'Pressure'. The 'Range' is set to 'Global'. The 'Min' value is 0 [Pa] and the 'Max' value is 2.6594 [Pa]. The 'Apply' button is highlighted. The main view shows a pressure contour plot of the simulation domain, with a color scale ranging from 0.000e+000 to 2.659e+000 [Pa].



### 14- Remove mark of true from pressure

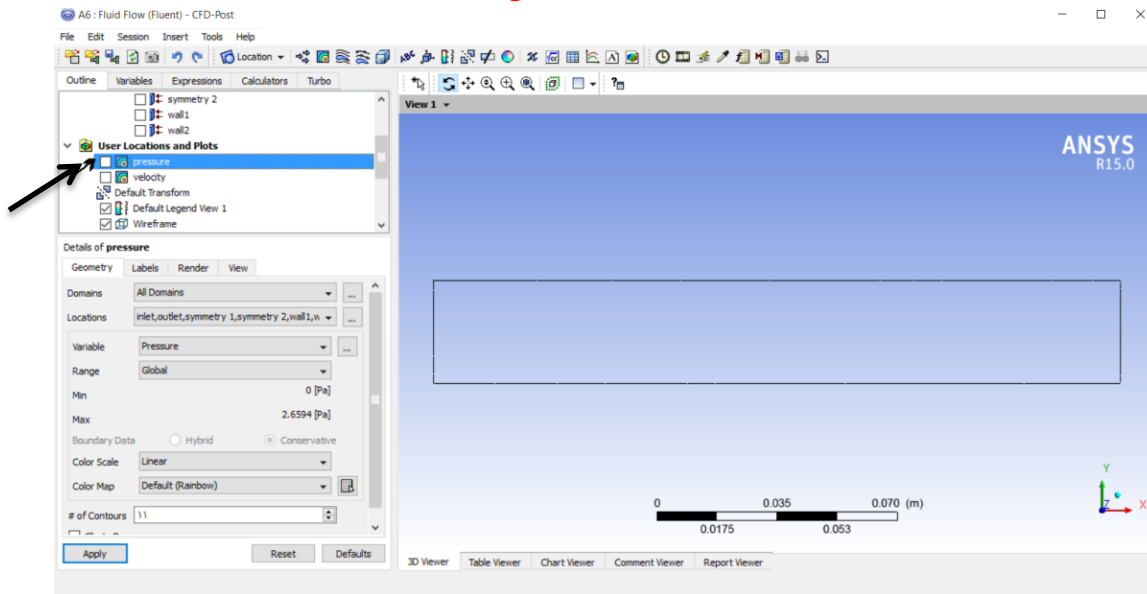

### 15- Results → Contour → create name (temperature) → ok

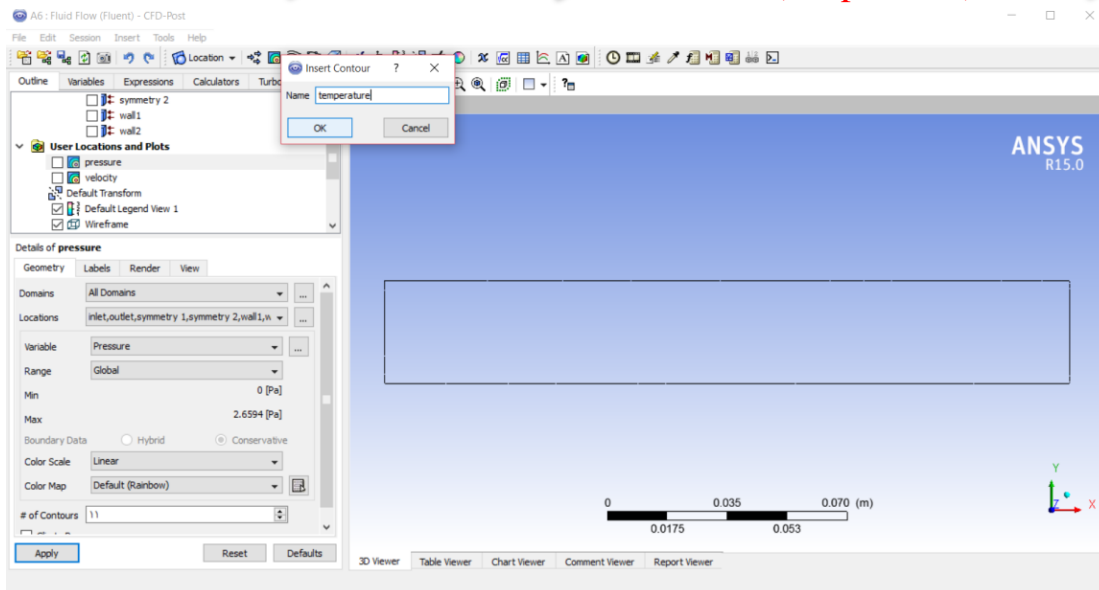



Class: third Stage  
Lecturer: Wuhood yassin Mohsin  
E-mail:wuhood.yassin@mustaqbal-college.edu.iq

16- Locations (select all) → ok → variable (select temperature) → apply

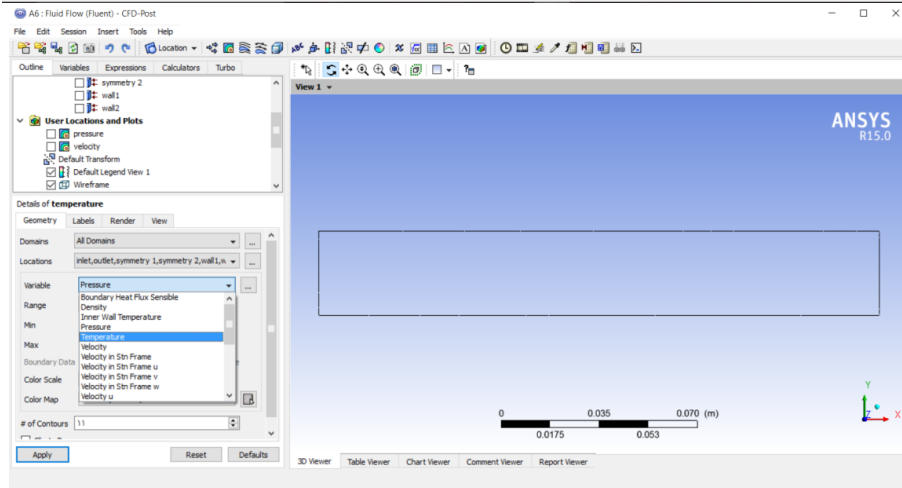
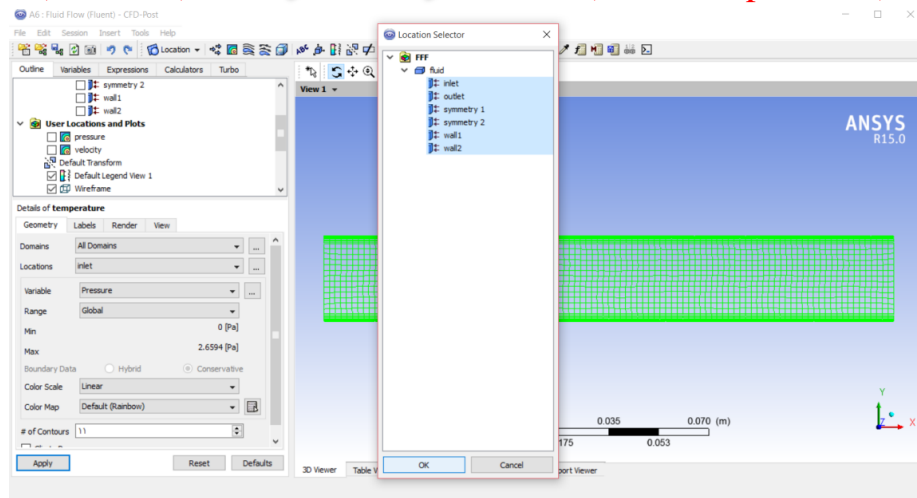



## Stream line

17- Results → Streamline1 → OK

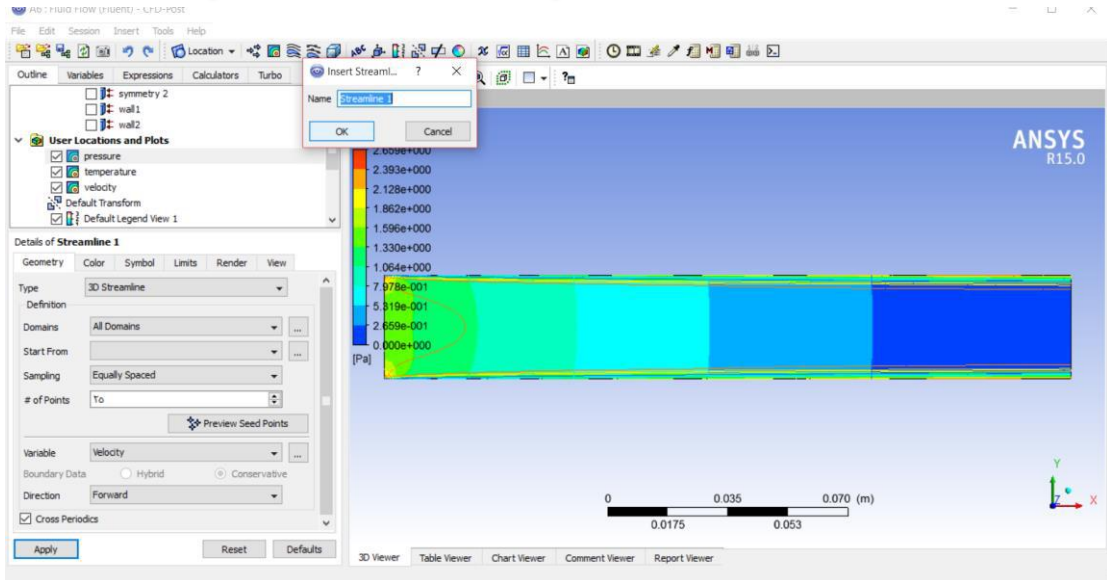

18- Remove all (✓) from Pressure and Temperature only.

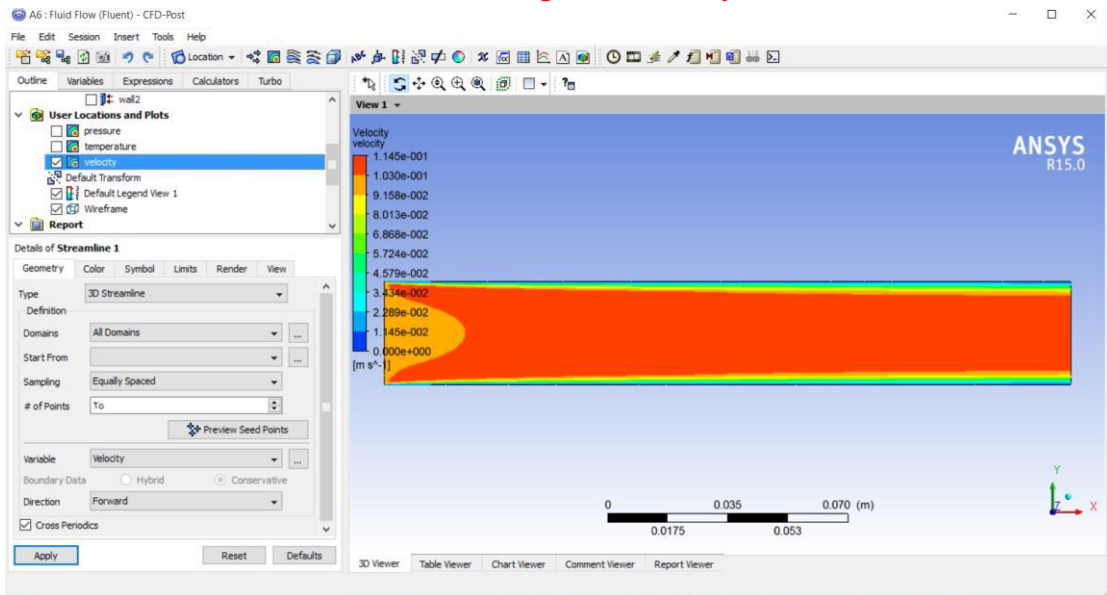





19- Start From (select all) → OK → apply

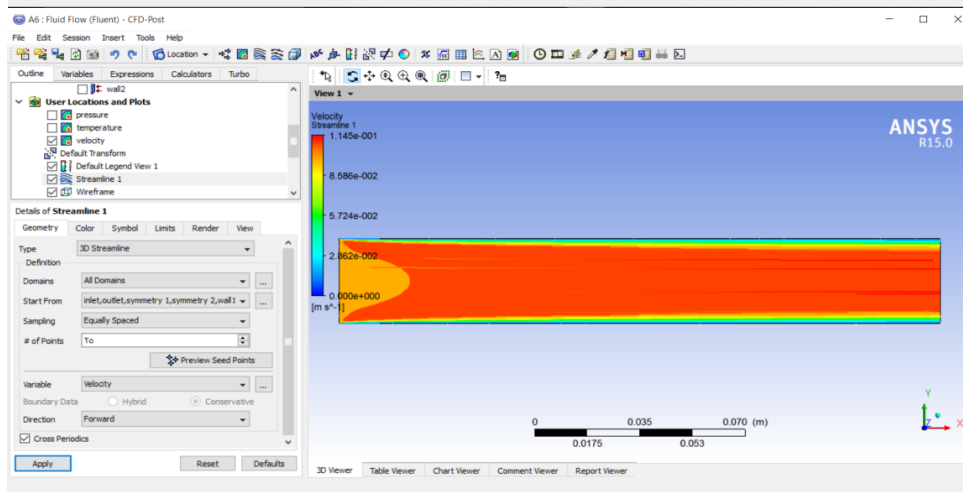
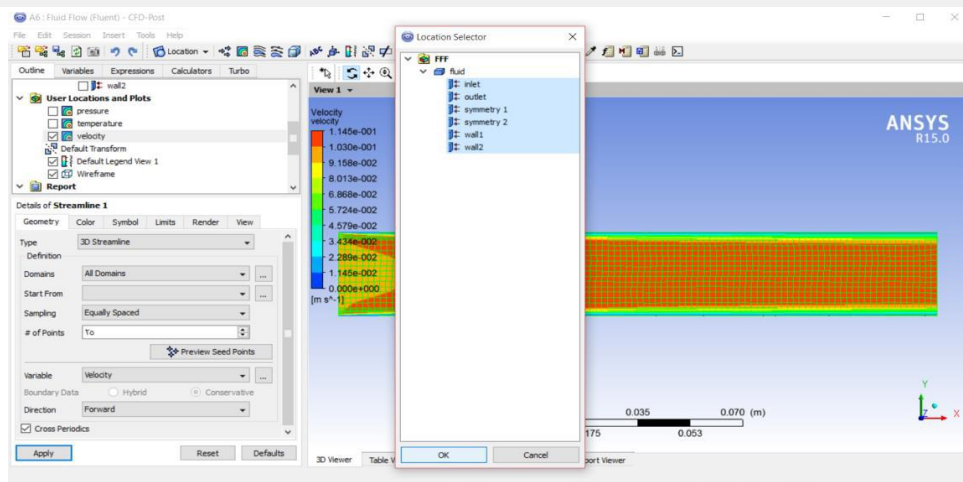
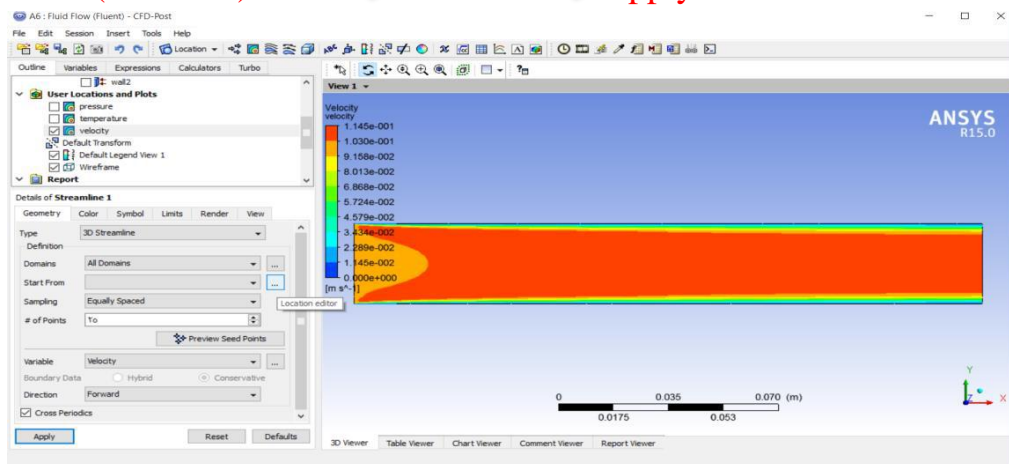



20- Make Video to appear changing in fluid velocity in pipe.

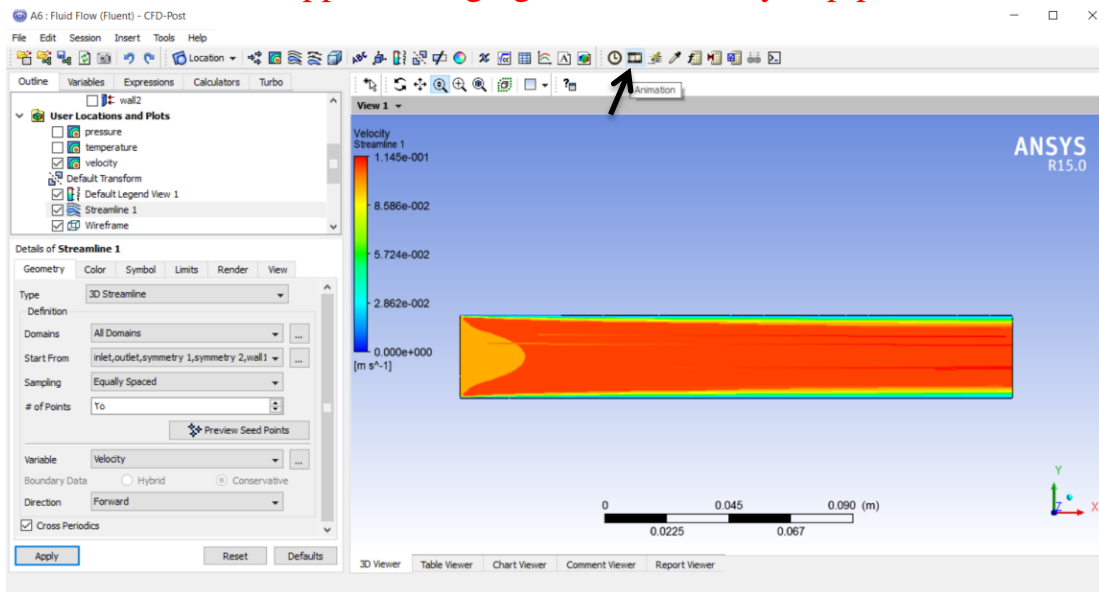

21- Select streamline1 → change video speed → play (to play video) → Stop to stop video)

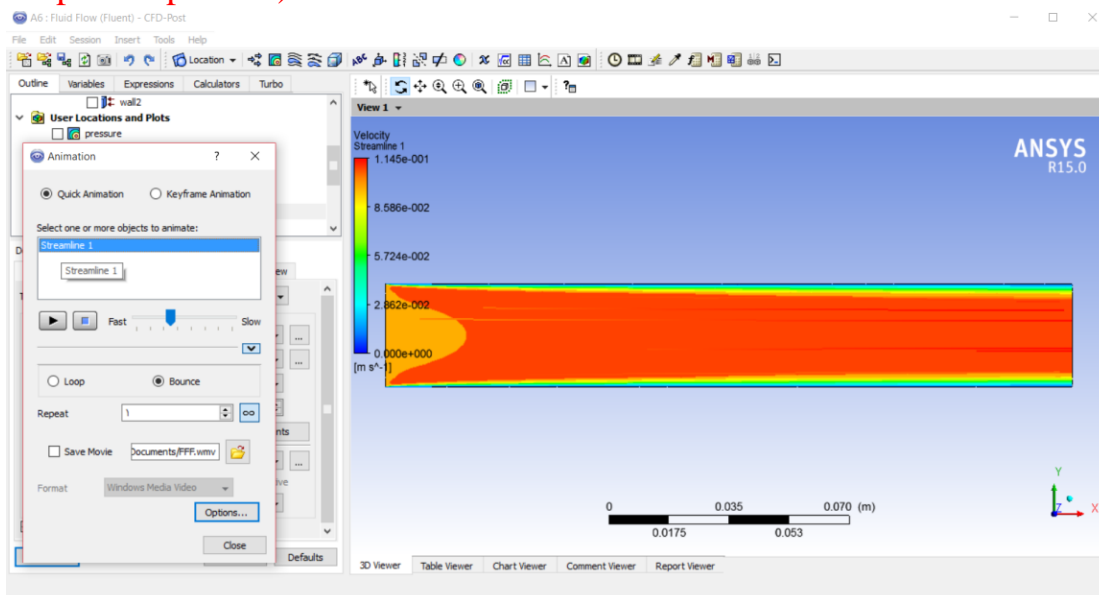



Class: third Stage  
Lecturer: Wuood yassin Mohsin  
E-mail:wurood.yassin@mustaqbal-college.edu.iq

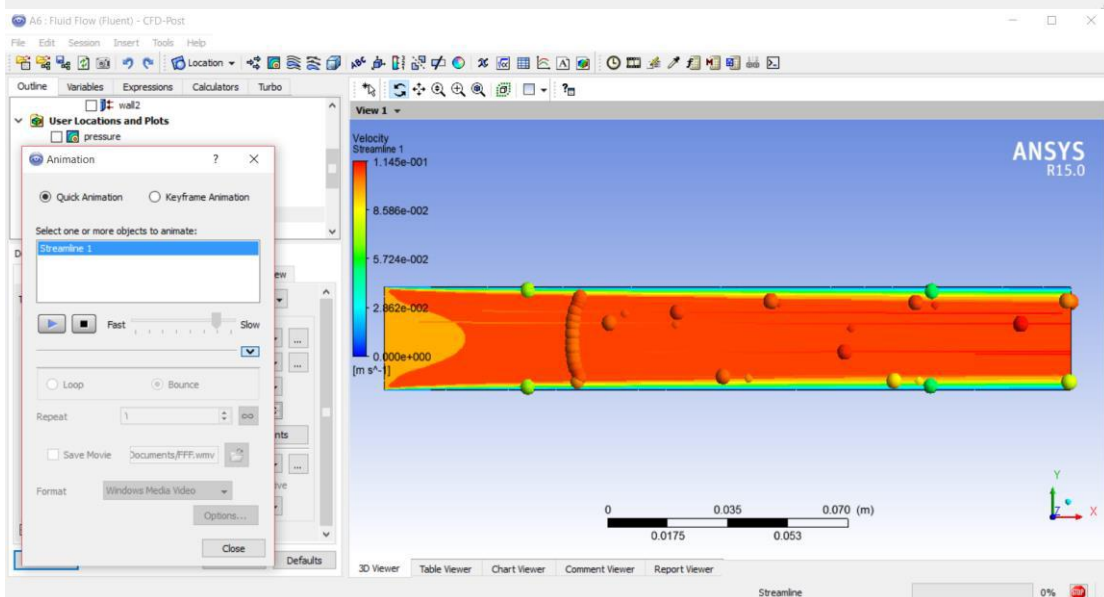
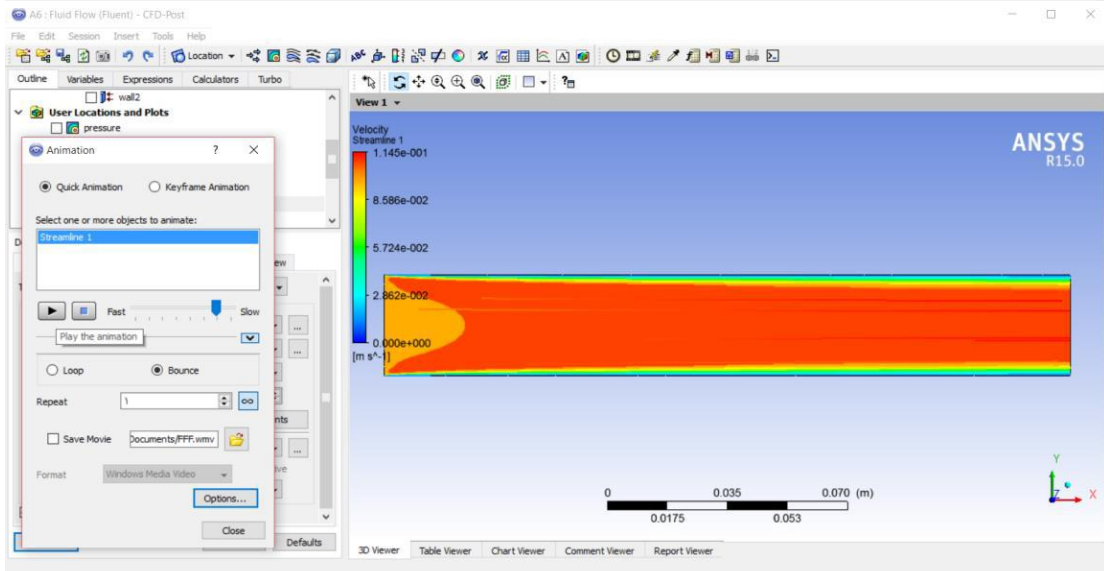
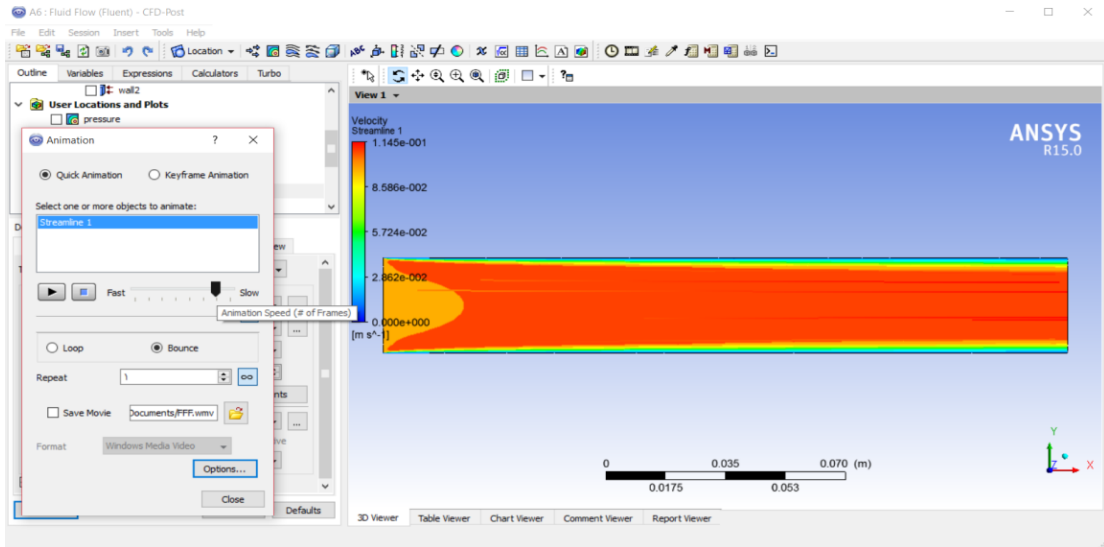



Class: third Stage  
Lecturer: Wuood yassin Mohsin  
E-mail:wuood.yassin@mustaqbal-college.edu.iq

